

User Manual

PDA

Phone

Please Read Before Proceeding

THE BATTERY IS NOT FULLY CHARGED WHEN YOU TAKE IT OUT OF THE BOX.

DO NOT REMOVE THE BATTERY PACK WHEN THE DEVICE IS CHARGING.





YOUR WARRANTY IS INVALIDATED IF YOU OPEN OR TAMPER WITH THE DEVICE'S OUTER CASING.

PRIVACY RESTRICTIONS

Some countries require full disclosure of recorded telephone conversations, and stipulate that you must inform the person with whom you are speaking that the conversation is being recorded. Always obey the relevant laws and regulations of your country when using the recording feature of your PDA Phone.

COPYRIGHT INFORMATION

Copyright © 2007 High Tech Computer Corp. All Rights Reserved.

     HTC, smart mobility ExtUSB and VueFLO are trademarks and/or service marks of High Tech Computer Corp.

Microsoft, MS-DOS, Windows, Windows NT, Windows Server, Windows Mobile, Windows XP, Windows Vista, ActiveSync, Windows Mobile Device Center, Internet Explorer, Windows Live, MSN, Hotmail, Outlook, Excel, PowerPoint, Word, and Windows Media are either registered trademarks or trademarks of Microsoft Corporation in the United States and/or other countries.

Bluetooth and the Bluetooth logo are trademarks owned by Bluetooth SIG, Inc.

Wi-Fi is a registered trademark of the Wireless Fidelity Alliance, Inc.

miniSD is a trademark of SD Card Association.

Java, J2ME and all other Java-based marks are trademarks or registered trademarks of Sun Microsystems, Inc. in the United States and other countries.

Copyright © 2006, Adobe Systems Incorporated.

Copyright © 2006, Macromedia Netherlands, B.V.

Opera® Browser from Opera Software ASA. Copyright 1995-2006 Opera Software ASA. All Rights Reserved.

Macromedia, Flash, Macromedia Flash, Macromedia Flash Lite and Reader are trademarks and/or registered trademarks of Macromedia Netherlands, B.V. or Adobe Systems Incorporated.

Copyright © 2006, JATAAYU SOFTWARE (P) LTD. All Rights Reserved.

Copyright © 2006, Dilithium Networks, Inc. All Rights Reserved.

ArcSoft MMS Composer™ Copyright © 2003-2006, ArcSoft, Inc. and its licensors. All Rights Reserved. ArcSoft and the ArcSoft logo are registered trademarks of ArcSoft, Inc. in the United States and/or other countries.

Sprite Backup is a trademark or service mark of Sprite Software.

Licensed by QUALCOMM Incorporated under one or more of the following patents:

4,901,307 ; 5,490,165 ; 5,056,109 ; 5,504,773 ; 5,101,501 ; 5,778,338 ; 5,506,865
5,109,390 ; 5,511,073 ; 5,228,054 ; 5,535,239 ; 5,710,784 ; 5,267,261 ; 5,544,196
5,267,262 ; 5,568,483 ; 5,337,338 ; 5,659,569 ; 5,600,754 ; 5,414,796 ; 5,657,420
5,416,797

All other company, product and service names mentioned herein are trademarks, registered trademarks or service marks of their respective owners.

HTC shall not be liable for technical or editorial errors or omissions contained herein, nor for incidental or consequential damages resulting from furnishing this material. The information is provided "as is" without warranty of any kind and is subject to change without notice. HTC also reserves the right to revise the content of this document at any time without prior notice.

No part of this document may be reproduced or transmitted in any form or by any means, electronic or mechanical, including photocopying, recording or storing in a retrieval system, or translated into any language in any form without prior written permission of HTC.

Important Health Information and Safety Precautions

When using this product, the safety precautions below must be taken to avoid possible legal liabilities and damages. Retain and follow all product safety and operating instructions. Observe all warnings in the operating instructions on the product.

To reduce the risk of bodily injury, electric shock, fire, and damage to the equipment, observe the following precautions.

ELECTRICAL SAFETY

This product is intended for use when supplied with power from the designated battery or power supply unit. Other usage may be dangerous and will invalidate any approval given to this product.

SAFETY PRECAUTIONS FOR PROPER GROUNDING INSTALLATION

CAUTION: Connecting to an improperly grounded equipment can result in an electric shock to your device.

This product equipped with a USB Cable for connecting with desk-top or notebook computer. Be sure your computer is properly grounded (earthed) before connecting this product to the computer. The power supply cord of a desktop or notebook computer has an equipment-grounding conductor and a grounding plug. The plug must be plugged into an appropriate outlet which is properly installed and grounded in accordance with all local codes and ordinances.

SAFETY PRECAUTIONS FOR POWER SUPPLY UNIT

- **Use the correct external power source**

A product should be operated only from the type of power source indicated on the electrical ratings label. If you are not sure of the type of power source required, consult your authorized service provider or local power company. For a product that operates from battery power or other sources, refer to the operating instructions that are included with the product.

This product should be operated only with the following designated power supply unit(s):

1. Delta, Model ADP-5FH X
2. Phihong, Models PSAA05X-050 and PSC05R-050

Car Adapter

1. Phihong, Model CLM10D-050
 2. Hwa Ying, Model AP-03
- **Handle battery packs carefully**

This product contains a Li-ion battery. There is a risk of fire and burns if the battery pack is handled improperly. Do not attempt to open or service the battery pack. Do not disassemble, crush, puncture, short external contacts or circuits, dispose of in fire or water, or expose a battery pack to temperatures higher than 60°C (140°F).



WARNING: DANGER OF EXPLOSION IF BATTERY IS INCORRECTLY REPLACED. TO REDUCE RISK OF FIRE OR BURNS, DO NOT DISASSEMBLE, CRUSH, PUNCTURE, SHORT EXTERNAL CONTACTS, EXPOSE TO TEMPERATURE ABOVE 60°C (140°F), OR DISPOSE OF IN FIRE OR WATER. REPLACE ONLY WITH SPECIFIED BATTERIES. RECYCLE OR DISPOSE OF USED BATTERIES ACCORDING TO THE LOCAL REGULATIONS OR REFERENCE GUIDE SUPPLIED WITH YOUR PRODUCT.



SAFETY PRECAUTIONS FOR DIRECT SUNLIGHT

Keep this product away from excessive moisture and extreme temperatures. Do not leave the product or its battery inside a vehicle or in places where the temperature may exceed 60°C (140°F), such as on a car dashboard, window sill, or behind a glass that is exposed to direct sunlight or strong ultraviolet light for extended periods of time. This may damage the product, overheat the battery, or pose a risk to the vehicle.

PREVENTION OF HEARING LOSS



CAUTION: Permanent hearing loss may occur if earphones or headphones are used at high volume for prolonged periods of time.

NOTE: For France, mobile headphones, earphones, and wired remote controllers (listed below) for this device have been tested to comply with the Sound Pressure Level requirement laid down in NF EN 50332-1:2000 and NF EN 50332-2:2000 standards as required by French Article L. 5232-1.

1. Earphone, manufactured by HTC or Cotron, Models CHM-60STV07004, CH-60ST006 and CH-60ST007.
2. Wired Remote Controller, manufactured by HTC, Model RC W100.

SAFETY IN AIRCRAFTS

Due to the possible interference caused by this product to an aircraft's navigation system and its communications network, using this device's phone function on board an airplane is against the law in most countries. If you want to use this device when on board an aircraft, remember to turn off the phone by switching to Flight Mode.

ENVIRONMENT RESTRICTIONS

Do not use this product in gas stations, fuel depots, chemical plants or where blasting operations are in progress, or in potentially explosive atmospheres such as fuelling areas, fuel storehouses, below deck on boats, fuel or chemical transfer or storage facilities, and areas where the air contains chemicals or particles, such as grain, dust, or metal powders. Please be aware that sparks in such areas could cause an explosion or fire resulting in bodily injury or even death.

EXPLOSIVE ATMOSPHERES

When in any area with a potentially explosive atmosphere or where flammable materials exist, the product should be turned off and the user should obey all signs and instructions. Sparks in such areas could cause an explosion or fire resulting in bodily injury or even death. Users are advised not to use the equipment at refueling points such as service or gas stations, and are reminded of the need to observe restrictions on the use of radio equipment in fuel depots, chemical plants, or where blasting operations

are in progress. Areas with a potentially explosive atmosphere are often, but not always, clearly marked. These include fueling areas, below deck on boats, fuel or chemical transfer or storage facilities, and areas where the air contains chemicals or particles, such as grain, dust, or metal powders.

ROAD SAFETY

Vehicle drivers in motion are not permitted to use telephony services with handheld devices, except in the case of emergency. In some countries, using hands-free devices as an alternative is allowed.

SAFETY PRECAUTIONS FOR RF EXPOSURE

- Avoid using your device near metal structures (for example, the steel frame of a building).
- Avoid using your device near strong electromagnetic sources, such as microwave ovens, sound speakers, TV and radio.
- Use only original manufacturer-approved accessories, or accessories that do not contain any metal.
- Use of non-original manufacturer-approved accessories may violate your local RF exposure guidelines and should be avoided.

INTERFERENCE WITH MEDICAL EQUIPMENT FUNCTIONS

This product may cause medical equipment to malfunction. The use of this device is forbidden in most hospitals and medical clinics.

If you use any other personal medical device, consult the manufacturer of your device to determine if it is adequately shielded from external RF energy. Your physician may be able to assist you in obtaining this information.

Turn the phone OFF in health care facilities when any regulations posted in these areas instruct you to do so. Hospitals or health care facilities may be using equipment that could be sensitive to external RF energy.

HEARING AIDS

Some digital wireless phones may interfere with some hearing aids. In the event of such interference, you may want to consult your service provider, or call the customer service line to discuss alternatives.

NONIONIZING RADIATION

This product should be operated in the suggested normal condition only to ensure the radiative performance and safety of the interference. As with other mobile radio transmitting equipment, users are advised that for satisfactory operation of the equipment and for the safety of personnel, it is recommended that no part of the human body be allowed to come too close to the antenna during operation of the equipment.

General Precautions

- **Heed service markings**

Except as explained elsewhere in the Operating or Service documentation, do not service any product yourself. Service needed on components inside these compartments should be done by an authorized service technician or provider.

- **Damage requiring service**

Unplug the product from the electrical outlet and refer servicing to an authorized service technician or provider under the following conditions:

- Liquid has been spilled or an object has fallen into the product.
- The product has been exposed to rain or water.
- The product has been dropped or damaged.
- There are noticeable signs of overheating.
- The product does not operate normally when you follow the operating instructions.

- **Avoid hot areas**

The product should be placed away from heat sources such as radiators, heat registers, stoves, or other products (including, but limited to, amplifiers) that produce heat.

- **Avoid wet areas**

Never use the product in a wet location.

- **Avoid using your device after a dramatic change in temperature**
When you move your device between environments with very different temperature and/or humidity ranges, condensation may form on or within the device. To avoid damaging the device, allow sufficient time for the moisture to evaporate before using the device.
- **NOTE:** When taking the device from low-temperature conditions into a warmer environment or from high-temperature conditions into a cooler environment, allow the device to acclimate to room temperature before turning on the power.
- **Avoid pushing objects into product**
Never push objects of any kind into cabinet slots or other openings in the product. Slots and openings are provided for ventilation. These openings must not be blocked or covered.
- **Mounting Accessories**
Do not use the product on an unstable table, cart, stand, tripod, or bracket. Any mounting of the product should follow the manufacturer's instructions, and should use a mounting accessory recommended by the manufacturer.
- **Avoid unstable mounting**
Do not place the product with an unstable base.
- **Use product with approved equipment**
This product should be used only with personal computers and options identified as suitable for use with your equipment.
- **Adjust the volume**
Turn down the volume before using headphones or other audio devices.
- **Cleaning**
Unplug the product from the wall outlet before cleaning. Do not use liquid cleaners or aerosol cleaners. Use a damp cloth for cleaning, but NEVER use water to clean the LCD screen.

- For magnetic devices



Please avoid putting any media that contains magnets, e.g. magnetic card, credit cards, bank cards, audio/video tape or magnetic memory devices, directly on the device or keyboard without any distance.



It is highly recommended to put the media containing magnets in a security distance of at least 5 cm. If you carry your wallet or billfold which contains magnetic cards next to the device or its keyboard, information stored on these cards could be destroyed.

Please make sure that there is an adequate distance from the device or its keyboard other magnetic sensitive devices, e.g., a mechanical watch or measure instruments

- For pacemakers



The functionality of pacemakers can be interfered by the device and its keyboard. Always keep the device and its keyboard in a fair distance to your pacemaker, which at least will be 5 cm. In any case, please do not carry the device and/or its keyboard in the front pockets of your shirt or coat.



For information about other medical active implants, please contact the producer or a doctor to ensure such active implants will not be interfered by magnetic field.

Contents

Chapter 1 Getting Started 17

1.1	Getting to Know Your Device and Accessories	18
1.2	About the USIM/SIM Card and Battery	23
1.3	Starting Up.....	25
1.4	The Today Screen.....	27
1.5	The Subdisplay	31
1.6	Using the Programs.....	32
1.7	Device Settings.....	34

Chapter 2 Entering and Searching Information 39

2.1	Using the Hardware Keyboard	40
2.2	Entering Information	42
2.3	Using the On-screen Keyboard	43
2.4	Using Letter Recognizer.....	43
2.5	Using Block Recognizer	44
2.6	Using Transcriber.....	44
2.7	Using Symbol Pad.....	46
2.8	Using Notes to Draw, Write, and Record Voice Notes	47
2.9	Searching Information	47

Chapter 3 Using Phone Features	49
3.1 Using the Phone	50
3.2 Making a Call	51
3.3 Receiving a Call.....	54
3.4 Smart Dialing.....	54
3.5 In-call Options	57
3.6 Additional Dialing Information.....	58
3.7 Setting Up Bluetooth SIM Access for Car Kit Phones.....	59
Chapter 4 Setting Up Your PDA Phone	61
4.1 Basic Settings.....	62
4.2 Personalizing the Today Screen	63
4.3 Customizing Phone Settings and Services	65
4.4 Protecting Your Device.....	67
4.5 Other Settings	68
Chapter 5 Synchronizing Information With Your Computer	73
5.1 About ActiveSync	74
5.2 Setting Up Microsoft Windows Mobile® Device Center on Windows Vista	75
5.3 Setting Up Microsoft ActiveSync® on Windows XP.....	76
5.4 Synchronizing with Your Computer	77
5.5 Synchronizing via Bluetooth	79

5.6	Synchronizing Music and Video	80
-----	-------------------------------------	----

Chapter 6 Organizing Contacts, Appointments, Tasks, and Other Information 81

6.1	Contacts	82
6.2	SIM Manager	85
6.3	Calendar	87
6.4	Tasks	90
6.5	Notes	92
6.6	Voice Recorder	94

Chapter 7 Exchanging Messages 97

7.1	Messaging	98
7.2	Text Messages	99
7.3	MMS Messages	100
7.4	Setting Up E-mail Accounts	106
7.5	Using E-mail	109

Chapter 8 Working With Company E-mails and Meeting Appointments 115

8.1	Synchronizing Your Device with the Exchange Server	116
8.2	Working With Company E-mails	121
8.3	Managing Meeting Requests	126
8.4	Finding Contacts in the Company Directory	127
8.5	E-mail Security	128

Chapter 9 Getting Connected	133
9.1 Using Comm Manager.....	134
9.2 Connecting to the Internet	135
9.3 Using VueFLO.....	140
9.4 Internet Explorer Mobile	141
9.5 Opera Browser	144
9.6 Using Bluetooth.....	145
9.7 Using Internet Sharing.....	155
Chapter 10 Using GPS	157
10.1 Guidelines and Preparation for Using GPS	158
10.2 Downloading Satellite Data via QuickGPS.....	159
10.3 Using GPS Software	161
10.4 GPS Controls	161
Chapter 11 Using Windows Live	163
11.1 Windows Live Mobile	164
11.2 Live Messenger.....	168
11.3 Sending Photos to Your Windows Live Space	171
Chapter 12 Experiencing Multimedia	175
12.1 Using Camera	176
12.2 Using Pictures & Videos	190
12.3 Using Windows Media Player Mobile	195
12.4 Using Streaming Media	202

Chapter 13 Using Other Applications	205
13.1 Word Mobile	206
13.2 Excel Mobile.....	207
13.3 Viewing Slide Shows with PowerPoint Mobile.....	207
13.4 Using Adobe Reader LE	208
13.5 Using MIDlet Manager	211
13.6 Using ZIP	214
13.7 Using Voice Speed Dial	216
Chapter 14 Managing Your PDA Phone	219
14.1 Adding and Removing Programs.....	220
14.2 Copying Files	221
14.3 Managing Memory.....	223
14.4 Backing Up Data.....	224
14.5 Resetting Your PDA Phone	227
14.6 Checking System Information.....	229
14.7 Battery Saving Tips	229
Appendix	231
A.1 Regulatory Notices	232
A.2 PC Requirement to Run ActiveSync 4.5	238
A.3 Specifications	239
Index	243

Chapter 1

Getting Started

1.1 Getting to Know Your Device and Accessories

1.2 About the USIM/SIM Card and Battery

1.3 Starting Up

1.4 The Today Screen

1.5 The Subdisplay

1.6 Using the Programs

1.7 Device Settings

1.1 Getting to Know Your Device and Accessories

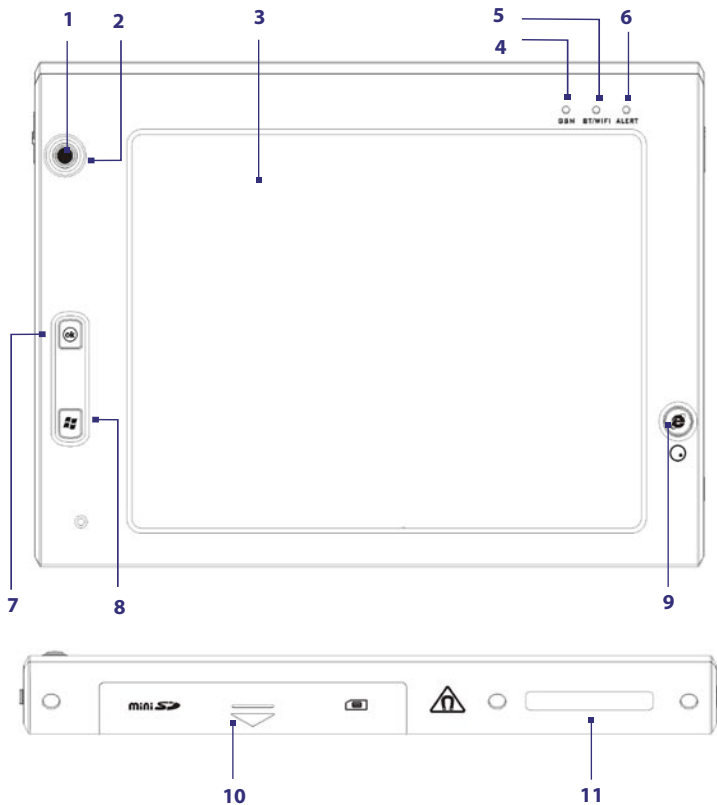

No.	Item	Function
1	Navigation Control/ CENTER OK button	Press this multi-directional control up, down, left, or right to move through menus and program instructions; carry out the selection by pressing the CENTER OK button.
2	Notification LED 1	This LED shows battery charging status.
3	Touch Screen	Tap the screen with the stylus to write, draw, or make a selection.
4	Notification LED 2	This LED shows the GSM/UMTS standby/ network status (Green). and GPS indicator (amber)
5	Notification LED 3	This LED shows the following: <ul style="list-style-type: none"> • A flashing Blue light for Bluetooth system notification of powered-up and ready to transmit radio frequency signal. • A flashing Green light for Wi-Fi status. • When both Bluetooth and Wi-Fi are enabled, their lights flash alternately.
6	Notification LED 4	This LED shows messages and notifications.
7	OK Button	Press to confirm your data entries, or to exit the program in use.
8	START Button	Press to open the Start menu.
9	Web Browser/VueFLO Button	Press to launch the Internet Explorer Mobile or Opera Browser and automatically go to the home page selected by default. Depending on the Web browser selected in VueFLO settings, press this button to activate VueFLO when browsing the Web.
10	Battery Compartment	Open this compartment to insert the SIM/USIM card, miniSD™ card and battery.
11	Keyboard Copper Connector	Attach the copper part of the keyboard to this to be able to use the keyboard. See "Using the Hardware Keyboard" in chapter 2 to learn how to attach the keyboard to the main unit.

20 Getting Started

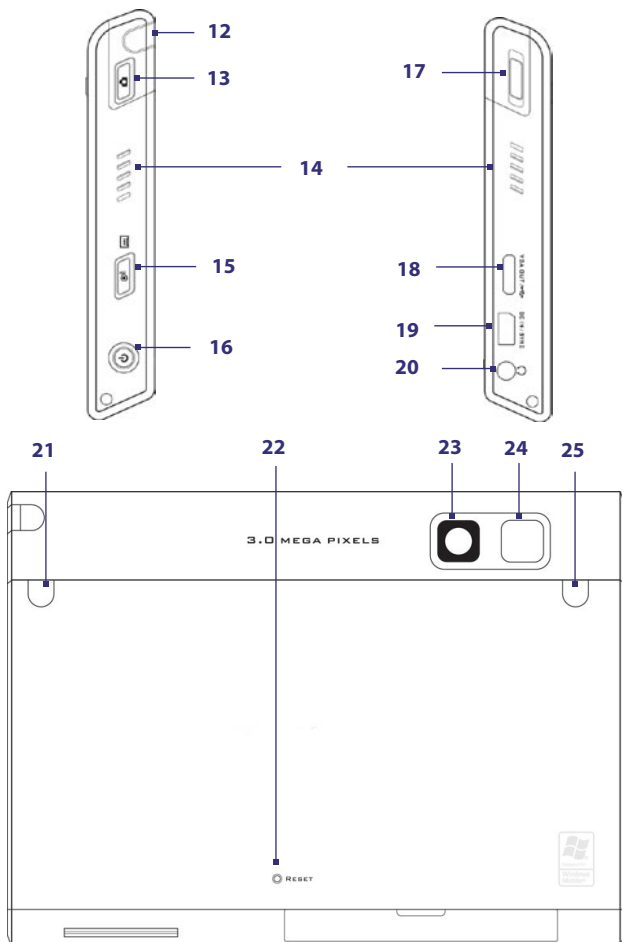

No.	Item	Function
12	Stylus	Use the stylus to write, draw, or select items on the touch screen.
13	CAMERA Button	Press to launch the Camera; press again to take a photo or video clip, depending on the specified capture mode.
14	Speaker	Listen to audio files and voice calls here.
15	COMM MANAGER/ VOICE RECORDER button	Press to open Comm Manager. Press and hold to open the Voice Notes program.
16	POWER Button	<ul style="list-style-type: none">• Press to turn off the display temporarily. This switches your device to Sleep mode. You can still receive calls and messages when your device is in Sleep mode.• Press and hold (for about 5 seconds) to turn off the power completely. All functions including the phone will be unavailable for use.
17	Volume Slider	<ul style="list-style-type: none">• Slide up or down to adjust the speaker volume.• During a call, slide up or down to adjust the earpiece volume.
18	VGA Out/USB port	Use this connection to output the contents on the screen to an external device using the provided VGA out cable. This also acts as a USB 1.1 host to connect USB peripherals.
19	HTC ExtUSB™ port	Use this connector to synchronize data by connecting the provided USB Sync cable or to recharge the battery via the provided AC adapter. You can also connect the provided USB stereo headset for hands-free conversation or for listening to audio media.
20	3.5 mm Earphone Jack	Lets you listen to audio media, use a hand-free kit or plug in a microphone.
21	Car Antenna Connector	Connect your device to the car antenna while in a car to have better reception quality.
22	RESET Button	With the stylus, press the RESET button to soft-reset your device.
23	Camera	Use the camera to take still photos and record video clips.
24	Flash Light	When turned on, it illuminates your subject and allows you to capture clear photos or video even in a dark environment. It also flashes when a photo is taken.
25	GPS Antenna Connector	If you need better GPS signal reception, you can connect an external GPS antenna.



No.	Item	Function
26	QWERTY keyboard	This is similar to a standard PC keyboard. Connect to the device to use the keyboard (Please see chapter 2). This also acts as a protective cover for the device screen.

Accessories

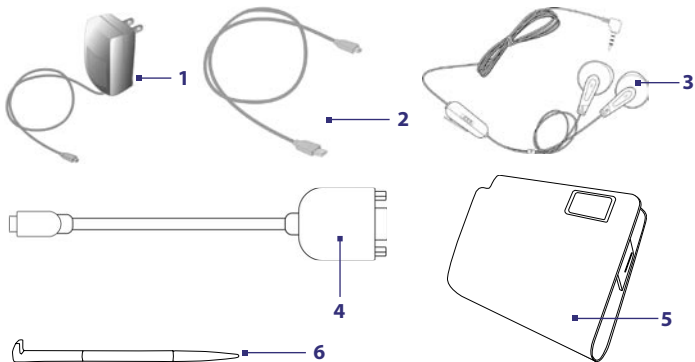

No.	Accessory	Function
1	AC adapter	Recharges the battery.
2	USB Sync cable	Connects your device to a PC and synchronizes data.
3	Stereo headset	Provides a volume control slider and a Send/End button. Press the Send/End button to pick up a call or put a call on hold; press and hold the button to end the call.
4	VGA Out cable	Connects your device to an external viewing device. You can output the contents on the device's screen to an external viewing device.
5	Carrying Case	Acts as a protective carrying case for your Athena.
6	Extra Stylus	Use to tap items onscreen.

1.2 About the USIM/SIM Card and Battery

Always turn off your device before installing/replacing the battery and USIM/SIM card. Follow the instructions in the Quick Start Guide to install a 3G USIM (Universal Subscriber Identity Module) or a SIM (Subscriber Identity Module) card provided by your local network service provider and to install the battery.

The USIM/SIM card contains your phone number, service details, and phonebook/message memory. Your device supports both 1.8V and 3V USIM/SIM cards. Some legacy SIM cards will not function with your device. You should consult with your service provider for a replacement SIM card. There may be fees for this service.

Your device contains a rechargeable Li-ion polymer battery. This device is designed to use only manufacturer-specified original batteries and accessories. Battery performance depends on many factors, including your wireless service provider's network configuration, signal strength, the temperature of the environment in which you operate your device, the features and/or settings you select and use, items attached to connecting ports, and your voice, data, and other program usage patterns.

Battery life estimates (approximations):

- Standby time: Up to **300** hours for GSM.
Up to **300** hours for UMTS.
- Talk time (Screen off): Up to **5.5** hours for GSM.
Up to **4.5** hours for UMTS.

Warning!

To reduce risk of fire or burns:

- Do not attempt to open, disassemble, or service the battery pack.
- Do not crush, puncture, short external contacts, or dispose of in fire or water.
- Do not expose to temperatures above 60°C (140°F).
- Replace only with the battery pack designated for this product.
- Recycle or dispose of used battery as stipulated by local regulation.

To check the battery power

Do one of the following:

- Tap the battery level icon () on the Today screen.
- Alternatively, tap **Start > Settings > Systems** tab > **Power**.



Battery power information

Charge the battery

The battery in the box is shipped partially charged. Before you start using your device, it is recommended that you install and charge the battery. Some batteries perform best after several full charge/discharge cycles. You can charge the battery in two ways:

- Charging the device's battery by using the power adapter.
- Connecting your device to a PC via the provided USB Sync cable.

Warning!

- Do not remove the battery from the device while you are charging it using the AC or car adapter.
- As a safety precaution, the battery stops charging when it overheats. Your device will use the power from the AC or car adapter to function.

Low battery

When the low-battery warning appears, do the following:

- Immediately save your current data.
- Connect the power adapter to charge the battery.
- Turn off your device.

1.3 Starting Up

Turn your device on and off

To turn on your device, press and hold the POWER button. When you turn on your device for the first time, a Quick Start Wizard will guide you through the calibration process and the setup of regional settings, date and time, password, Outlook e-mail, and POP3/IMAP4 e-mail accounts. For more information about touch screen calibration, see “Calibrate the device.” For information about setting up Outlook e-mail and POP3/IMAP4 e-mail accounts, see Chapter 7.

To turn off your device, press and hold the POWER button for a few seconds. A message will then be displayed, prompting you whether or not to turn off the device completely.

Switching your device to Sleep mode

Quickly pressing the POWER button turns off the display temporarily and switches your device to **Sleep mode**. Sleep mode suspends your device to a low power state while the display is off in order to save battery power.

Your device also automatically goes into Sleep mode when you leave the device idle after a certain amount of time.

When the keyboard is attached to the LCD screen, pressing the POWER button toggles between turning on and off the subdisplay screen.

To specify the timeout period before your device goes into Sleep mode

1. Tap **Start > Settings > System tab > Power > Advanced tab**.
2. Under **On battery power**, make sure the **Turn off device if not used for** check box is selected.
3. Select the battery timeout period, then tap **OK**.

You will still be able to receive messages and calls while your device is in Sleep mode. Pressing the POWER button again or new incoming calls/messages will wake up your device.

Calibrate the device

Calibrating the device screen involves tapping the center of a cross with the stylus as the cross moves around the screen. This process ensures that when you tap the screen with your stylus, the tapped item is activated.

If your device does not accurately respond to screen taps, follow these steps to re-calibrate it:

1. Tap **Start > Settings > System tab > Screen**.
2. On the **General** tab, tap **Align Screen**, then follow the on-screen instructions to complete the calibration.

Manage screen settings

The device's display has two orientation modes: **Landscape** and **Portrait**. Portrait mode allows you to get a better view or a better operation of certain programs, while Landscape mode may be optimal for viewing lengthy files.

- To change the orientation, tap **Start > Settings > System tab > Screen**, and select the orientation you want.
- To smooth the edges of screen fonts for many programs, on the **ClearType** tab, select the **Enable ClearType** check box.
- To increase the readability or to see more content on the screen, on the **Text Size** tab, adjust the text size by moving the slider.

1.4 The Today Screen

The Today screen displays important information, such as upcoming appointments and status indicators. You can tap a section on the screen to open the associated program.

- To access the Today screen, tap **Start > Today**.
- To customize the Today screen display, including the background image, tap **Start > Settings > Personal tab > Today**.

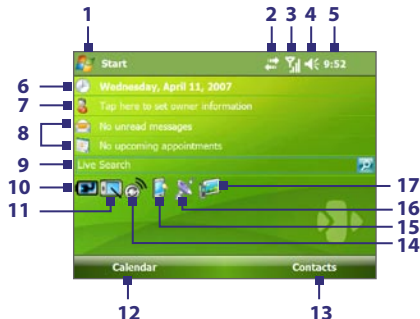





































- 1 Tap to open the Start menu.
- 2 Tap to view connectivity status.
- 3 Indicates the radio signal strength. Tap to configure the phone settings.
- 4 Tap to adjust device/ringer volume.
- 5 Displays the current time. Tap to check the current date and upcoming appointments. Tap and hold to change the clock mode to Analog or Digital.
- 6 Displays the current date. Tap to set up date, time, alarm, and more.
- 7 Tap to set owner information.
- 8 Your day at a glance with reminders. Tap to open the related program: messages and appointments.
- 9 Lets you search for information on the Web.
- 10 Indicates the battery status. Tap to open the Power Settings screen.
- 11 Tap to toggle the screen between portrait and landscape orientation.
- 12 Tap to open Calendar.











- 13 Tap to open Contacts.
- 14 Tap to open Comm Manager.
- 15 Tap to open the Backlight Settings screen.
- 16 Tap to open QuickGPS.
- 17 Tap to open and configure TV Out settings.

Indicators

The following are some of the status icons that you may see on the device.

Icon	Description
	New text messages; SMS notification of voice mail.
	New MMS message received.
	Receiving MMS message.
	Sending MMS message.
	Cannot send MMS message.
	There are more notifications. Tap the icon to view all.
	Speakerphone on.
	Dialing while no USIM/SIM card is inserted.
	Voice call in progress.
	Calls are forwarded.
	Call on hold.
	Missed call.
	Maximum signal strength.
	No signal.
	Phone is turned off.
	No phone service.

Icon	Description
	Searching for phone service.
	3G UMTS network available.
	UMTS connecting.
	UMTS in use.
	GPRS available.
	GPRS connecting.
	GPRS in use.
	EDGE available.
	EDGE connecting.
	EDGE in use.
	Roaming.
	Connection is active.
	Connection is not active.
	Synchronization in progress.
	Synchronization error.
	ActiveSync notification.
	Wi-Fi function enabled, but device not connected to a wireless network yet.
	Wireless network(s) detected.
	Connecting to wireless network (arrows moving); Connected to wireless network.
	Synchronizing via Wi-Fi.

Icon	Description
	Sound on.
	Sound off.
	Alarm.
	No USIM/SIM card inserted.
	VueFLO activated.
	Battery is fully charged.
	Battery power is very low.
	Battery charging.
	Bluetooth headset detected.
	QuickGPS update notification.
	Serial USB connection active.

Note The USB to PC () icon appears on the Today Screen when your device is connected to your computer and you enable a serial USB connection between them. For more information about USB to PC, see “Device Settings” later in this chapter.

The Start menu

The Start menu, located at the top left corner of the Today screen, displays a list of programs. You can start a program by scrolling through the programs list and then pressing the CENTER OK button, or by tapping a program with the stylus.



- 1 Tap to start a recently-used program.
- 2 Tap to switch to the Today screen.
- 3 Tap to start a program. The items displayed in the Start menu can be customized by tapping **Start > Settings > Personal tab > Menus**.
- 4 Tap to view and select more programs that are installed on your device.
- 5 Tap to change device settings.
- 6 Tap to see a Help topic for the current screen.

1.5 The Subdisplay

The Subdisplay lets you view notifications, music info, weather, temperature and time on a designated area on the LCD screen when the keyboard is attached to the LCD screen of the main unit. The Subdisplay is automatically activated when the keyboard is pressed against the LCD screen.











Note Weather, world time and temperature information are only available if the WorldMate® software is installed.

For more information regarding the Subdisplay, please refer to the Quick Start Guide.



1.6 Using the Programs

















The following are some of the programs that are already installed on your device.







Programs in the Start Menu

Icon	Description
	Office Mobile Use the complete suite of Microsoft® Office applications for your mobile device.
	Excel Mobile Create new workbooks or view and edit Microsoft® Excel® workbooks.
	PowerPoint Mobile View Microsoft® PowerPoint® slides and presentations.
	Word Mobile Create, view, and edit Microsoft® Word documents.
	Calendar Keep track of your appointments and create meeting requests.
	Contacts Keep track of your friends and colleagues.
	Internet Explorer Mobile Browse Web and WAP sites as well as download new programs and files from the Internet.
	Messaging Send and receive e-mail, MMS, and text messages.
	Phone Make and receive calls, switch between calls, and set up conference calling.
	Help See Help topics for a program on your device.

Programs screen

Icon	Description
	ActiveSync Synchronize information between your device and a PC or the Exchange Server.
	Adobe Reader LE View PDF (Portable Document Format) files on your device.
	Bluetooth Explorer Search for other Bluetooth devices that have file sharing enabled and access their Bluetooth shared folder.







Icon	Description
	Calculator Perform basic arithmetic and calculations, such as addition, subtraction, multiplication, and division.
	Camera Take photos or shoot video clips with accompanying audio.
	File Explorer Organize and manage files on your device.
	Games Play two pre-installed games: Bubble Breaker and Solitaire .
	Internet Sharing Connect your notebook computer to the Internet using your device's data connection.
	Messenger Use this mobile version of Windows Live Messenger.
	MIDlet Manager Download and install Java applications, such as games and tools, on your device.
	Notes Create handwritten or typed notes, drawings, and recordings.
	Opera Browser Browse Web sites.
	Pictures & Videos View and manage pictures, animated GIFs, and video files on your device or a storage card.
	QuickGPS Download satellite data over the Internet via ActiveSync, Wi-Fi or GPRS to speed up the time for determining your current GPS position.
	SAPSettings Enable Bluetooth Remote SIM access on your device. This allows you to use a car kit phone that supports the SIM Access Profile (SAP) to access the SIM card on your device via Bluetooth and make or receive phone calls. You can also download SIM contacts from your device onto the car kit phone.
	Search Search contacts, data, and other information on your device.
	SIM Manager Manage the contacts that are stored on your SIM card. You can also use this program to copy SIM contents to Contacts on your device.
	Sprite Backup Provide you with a quick and easy way to make backups of your data.
	STK (SIM Tool Kit) Service Access information and other services offered by your wireless service provider.



Icon	Description
	Streaming Media Stream live or on-demand video.
	Tasks Keep track of your tasks.
	Voice Recorder Record a voice clip and quickly send it through MMS or e-mail, beam it or set it as a ringtone.
	Voice Speed Dial Record voice tags so that you can dial a phone number or launch programs simply by speaking a word.
	Voice Speed Dial Record voice tags so that you can dial a phone number or launch programs simply by speaking a word.
	Windows Media Player Mobile Play back video and audio files.
	ZIP Save memory and free up storage space on your device by compressing files in the conventional ZIP format.

1.7 Device Settings











You can adjust the device settings to suit the way you work. To see all available settings, tap **Start > Settings**, then tap the **Personal**, **System**, and **Connections** tabs located at the bottom of the screen.

Personal tab

Icon	Description
	Buttons Assign a program or function to a hardware button.
	Input Set options for each of the input methods.
	Lock Set a password for your device.
	Menus Set what programs will appear in the Start menu.
	Owner Information Enter your personal information on your device.
	Phone Customize phone settings such as ring tone, set a PIN number for your SIM card, and more.











Icon	Description
	Sounds & Notifications Enable sounds for events, notifications, and more, and allows you to set the type of notification for different events.
	Today Customize the appearance and the information to be displayed on the Today screen.
	Voice Speed Dial Create voice tags for voice dialing contacts and SIM contacts as well as for launching programs.

System tab

Icon	Description
	About This is where you can see basic information such as the Windows Mobile® version and type of processor used on your device. You can also specify a name for your device.
	Backlight Set the backlight timeout and brightness.
	Certificates See information about certificates that are installed on your device.
	Clear Storage Tap this icon only when you need to remove all your data and files from the memory and reset your device to factory default settings.
	Clock & Alarms Set the device clock to the date and time of your locale or to a visiting time zone when you're traveling. Alarms can also be set at specified days and times of a week.
	Customer Feedback Send feedback to the Customer Experience Improvement Program of Microsoft.
	Device Information See information about the firmware version, hardware, identity, and the duration of calls made on your device.
	Encryption Allow files on your storage card to be encrypted. Encrypted files will be readable only on your device.
	Error Reporting Enable or disable the device's error reporting function. When this function is enabled and a program error occurs, technical data about the state of the program and your computer will be logged in a text file and delivered to Microsoft's technical support if you choose to send it.
	External GPS Set the appropriate GPS communication ports, if required. You may need to do this when there are programs on your device that access GPS data or you have connected a GPS receiver to your device. See Help for details.

Icon	Description
	Format Microdrive Erase all data and quickly format the Microdrive in your device.
	Key Lock Lock the buttons on your device except for the POWER button when the device is in Sleep mode. This ensures you will not switch the device on by accident and consume unnecessary power.
	Memory Check the device memory allocation status and memory card information. You can also stop currently running programs.
	Microphone AGC Adjust the volume of your voice automatically when you are recording.
	Power Check the remaining battery power. You can also set the timeout for turning off the display (switching device to Sleep mode) to conserve battery power.
	Regional Settings Set the regional configuration to use, including the format for displaying numbers, currency, date, and time on your device.
	Remove Programs Remove programs that you installed on your device.
	Screen Change the screen orientation, re-calibrate the screen, and change the screen text size.
	Task Manager Set the Exit button () to end programs or to just hide program screens when you tap the button. You can also choose to show or hide the Quick Menu.
	TV Out Output the contents you are viewing on the device screen to an external display device.
	VueFLO Open the VueFLO settings where you can adjust the sensitivity level of VueFLO and choose the Web browser where VueFLO can be enabled. VueFLO lets you scroll through Web pages by simply tilting your device. In VueFLO, tap Tutorial to learn how to use VueFLO.
	Windows Update Link to Microsoft's Web site and update Windows Mobile® on your device with the latest security patches or fixes.

Connections tab

Icon	Description
	Beam Set your device to receive incoming Bluetooth beams.
	Bluetooth Turn Bluetooth on, set your device to visible mode, and scan for other Bluetooth devices.
	Comm Manager Manage your device's connections (including Wi-Fi, GPRS, Bluetooth, and ActiveSync), turn the phone on or off, switch to ringer/vibration mode, and enable or disable the Direct Push function.
	Connections Set up one or more types of modem connections for your device, such as phone dial-up, GPRS, Bluetooth, and more, so that your device can connect to the Internet or a private local network.
	CSD Line Type Set the line type to use when making a circuit switch data (CSD) connection. Normally, you do not need to change the setting unless you encounter a problem on establishing a connection.
	GPRS Setting Set the GPRS authentication method. This has been configured for the MEdia Net network.
	SMS Service Send SMS text messages via a data connection, such as GPRS or a circuit-switched connection. This can be used only if your wireless service provider supports this service.
	USB to PC indicates a serial connection between your device and PC using a USB cable. See "Sync connection problem" in Chapter 5 for details.
	Wi-Fi Scan for available wireless networks.
	Wireless LAN See information about the active wireless network, and customize Wi-Fi settings.

Chapter 2

Entering and Searching Information

- 2.1 Using the Hardware Keyboard**
- 2.2 Entering Information**
- 2.3 Using the On-screen Keyboard**
- 2.4 Using Letter Recognizer**
- 2.5 Using Block Recognizer**
- 2.6 Using Transcriber**
- 2.7 Using Symbol Pad**
- 2.8 Using Notes to Draw, Write, and Record Voice Notes**
- 2.9 Searching Information**

2.1 Using the Hardware Keyboard

Your device provides you with a **QWERTY** keyboard, which is similar to a standard keyboard on your PC. To use the QWERTY keyboard, attach the main unit to the keyboard (as shown in the image). The main unit securely attaches itself to the keyboard through a magnet.

To separate the main unit from the keyboard, simply pull them apart.

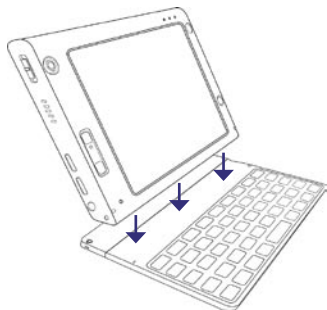





















Note When separating the keyboard from the main unit, please do so in a gentle way.

Warning! Please avoid placing credit cards, diskettes, audio or video cassettes or any other form of magnetic data carriers near the device or the keyboard as this could otherwise lead to loss of data stored on such objects. Other magnetic sensitive devices like a mechanical wristwatch should also not be placed near the device or keyboard.



You can do the following with the QWERTY keyboard:





- To type lowercase letters, press the keys using your thumbs or fingers.
- To use all uppercase letters, press  first, then press . To change back to all lowercase letters, press these buttons again.
- To use a single uppercase letter, press  and then press the corresponding key.
- To enter a number or symbol (labeled in blue color), press  and then press the corresponding key.
- To open the Symbol Pad, press  and then press .
- Press the Left/Right SOFT KEY  /  to perform the command shown in the label above the key.
- Press  to verify your data entries or exit the program in use.
- Press  to open the Start menu.
- Press the arrow keys  /  /  /  for directional movement.
- To type accented characters (like á, ã, ç, ê, í, ó, ü, etc), press the letter key first and then, hold  and at the same time press the space bar  several times until you find the correct character you need.
- Press  to open the Messaging program.
- Press  to answer a call, make a call or send a message. Press and hold to toggle between enabling and disabling the speakerphone.
- Press  to end a call or cancel a message.
- Press  to turn the screen back on if the device is set to sleep mode.
- Press  to open the Internet Explorer Mobile Browser.

2.2 Entering Information

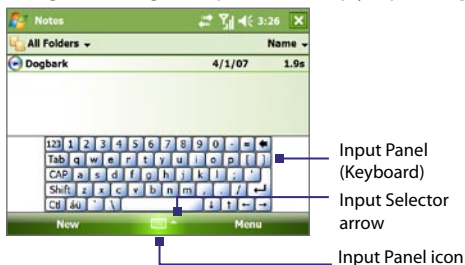
When you start a program or select a field that requires text or numbers, the **Input Panel** icon becomes available on the menu bar.

Tap the **Input Selector** arrow (that appears next to the **Input Panel** icon) to open a menu where you can select a text input method and customize input options. After selecting a text input method, the corresponding **Input Panel** is then displayed and you can use it to enter text. To toggle between showing and hiding the Input Panel, simply tap the **Input Panel** icon.



Icon	Input method
	On-screen keyboard
	Letter Recognizer or Block Recognizer
	Symbol Pad
	Transcriber

Options...
<input type="checkbox"/> Block Recognizer
<input checked="" type="checkbox"/> Keyboard
<input type="checkbox"/> Letter Recognizer
<input type="checkbox"/> Symbol Pad
<input type="checkbox"/> Transcriber

Note Some text input methods may not be available in certain language versions of the device.

2.3 Using the On-screen Keyboard

The on-screen **Keyboard** is available when text entry is possible. You can enter text by tapping keys on the keyboard that are displayed on the screen.

To enter text using the on-screen Keyboard

1. In a program, tap the **Input Selector** arrow, and tap **Keyboard**.
2. Enter text by tapping keys on the on-screen Keyboard.

To enlarge the on-screen Keyboard

1. Tap the **Input Selector** arrow, then tap **Options**.
2. In the **Input method** list, select **Keyboard**.
3. Tap **Large keys**.

2.4 Using Letter Recognizer

With **Letter Recognizer**, you can write individual letters, numbers, and punctuation, which are then converted into typed text.

To use Letter Recognizer

1. From a program, tap the **Input Selector** arrow, and tap **Letter Recognizer**.
2. Write characters, numbers, and symbols in the designated writing area.
 - Enter capital letters by writing in the **ABC** (left) area of the box.
 - Enter lower case letters by writing in the **abc** (middle) area of the box.
 - Enter numbers by writing in the **123** (right) area of the box.
 - Enter punctuation and symbols by tapping in either area of the box and then writing the desired character.

Note **Letter Recognizer** is available when text entry is possible.

Tip For help with writing characters, tap the question mark near the writing area.

2.5 Using Block Recognizer

With **Block Recognizer**, you use a single stroke to write letters, numbers, symbols, and punctuation, which are then converted into typed text.

To use Block Recognizer

1. From a program, tap the **Input Selector** arrow, and tap **Block Recognizer**.
2. Write characters, numbers, and symbols in the designated writing area.
 - Enter letters by writing in the **abc** (left) area of the box.
 - Enter numbers by writing in the **123** (right) area of the box.
 - Enter symbols and punctuation by tapping in either area of the box and then writing the desired character.

Note **Block Recognizer** is available when text entry is possible.

Tip For help with writing characters with **Block Recognizer**, tap the question mark near the writing area.

2.6 Using Transcriber

Transcriber is a handwriting recognition program that allows you to write in cursive, print, or a combination of both. Transcriber works transparently in the background of programs, recognizing words with its integrated dictionary. When Transcriber is turned on, it interprets stylus movement anywhere on the screen as handwriting input. For more information about using Transcriber, see Help on your device.

To start Transcriber

1. Start a program that accepts user input, such as Word Mobile.
2. Tap the **Input Selector** arrow, and tap **Transcriber**. The Transcriber introductory screen appears.

To write using Transcriber

1. In a program, position the cursor where you want text to appear.
2. Use the stylus to write anywhere on the screen. The handwriting will be converted to text shortly after you lift the stylus from the screen.

To enter punctuation and symbols

Transcriber comes with an on-screen keyboard that provides an easy way to add punctuation or a special symbol to existing text.

- From a program, tap  on the Transcriber toolbar.

The keyboard remains visible until you tap the button again.

- Tips**
- To reposition the keyboard, tap and hold the title bar, then drag to the desired location.
 - When no text is selected, you can also open the keyboard by doing the  gesture. For more information about using Transcriber gestures, see Help on your device.

To edit text

1. In a program, draw a line across the text you want to edit.
2. After you lift the stylus from the screen, the line will disappear and the selected text will be highlighted.
3. Do either of the following:
 - Rewrite the text.
 - Use gestures to capitalize letters, insert a space, and so on. For information about using Transcriber gestures, see Help on your device.

2.7 Using Symbol Pad



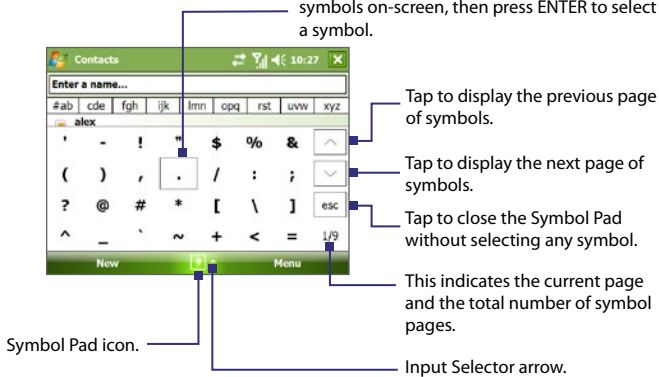

Symbol Pad provides a comprehensive list of common symbols such as parentheses, brackets, currency signs, and more, as well as punctuation marks and special characters.

Tap a symbol to select it.

When using the Navigation Control or the hardware keyboard, press UP, DOWN, LEFT, or RIGHT to navigate through the available symbols on-screen, then press ENTER to select a symbol.



To open the Symbol Pad and select a symbol

1. Create or open a document, such as a Word document.
2. To open the Symbol Pad:
 - Tap the **Input Selector** arrow, then tap **Symbol Pad**; or
 - Using the hardware keyboard, press  and then press .
3. To browse through the pages of symbols, tap  /  on the Symbol Pad screen.
4. Tap a symbol to select it and close the Symbol Pad. The selected symbol will then be inserted in your document.

2.8 Using Notes to Draw, Write, and Record Voice Notes

Using **Notes**, you can draw directly on the screen, or write on the screen and save notes in your own handwriting. You can also create a stand-alone recording (voice note) or you can add a recording to a note.

For more information on what you can do with Notes, see “Notes” in Chapter 6.

2.9 Searching Information

You can search for files and other items stored in My Documents folder or on an installed storage card of your device. You can search by file name or by words located in the item. For example, you can search in e-mail messages, notes, appointments, contacts, and tasks, as well as in online Help.

To search for a file or an item

1. Tap **Start > Programs > Search**.
2. In the **Search for** field, you can:
 - Enter the file name, word, or other information you want to search for.
 - Tap the down arrow icon (▼), and from the list, select one item that you have looked for before.
3. In the **Type** field, you can tap the down arrow icon (▼) and select a data type from the list to help narrow your search.
4. Tap **Search**. The system start searching the matched files in **My Documents** folder and subfolders.
5. In the **Results** list, tap the item you want to open.

Note The symbol  is displayed next to the names of files saved on a storage card or the Microdrive.

Chapter 3

Using Phone Features

3.1 Using the Phone

3.2 Making a Call

3.3 Receiving a Call

3.4 Smart Dialing

3.5 In-call Options

3.6 Additional Dialing Information

**3.7 Setting Up Bluetooth SIM Access
for Car Kit Phones**

3.1 Using the Phone

Like a standard mobile phone, you can use your device to make, receive, and keep track of calls and send SMS/MMS messages. You can also dial directly from Contacts, and easily copy phonebook entries from your SIM card to Contacts on your device.

The Phone screen

From the Phone screen, you can access Call History, Speed Dial, and Phone settings. To open the Phone screen, tap **Start > Phone**.

Enter your PIN

Most SIM cards are preset with a PIN (personal identification number) that is provided by your wireless service provider. You need to enter the PIN whenever you use your device.

1. Enter the preset PIN assigned by your wireless service provider.
2. Tap **Enter**.

Note If your PIN is entered incorrectly three times, the SIM card will be blocked. If this happens, you can unblock it with the PUK (PIN Unblocking Key) obtained from your wireless service provider.

Turn the phone function on and off

In many countries, you are required by law to turn off your phone while on board an aircraft.

To turn off the phone function, do one of the following:

- Tap the **Comm Manager** icon () on the Today screen. On the Comm Manager screen, tap the **Phone** button to turn off the phone function.

To resume call function, turn on the phone function by tapping the **Phone** button again on the Comm Manager screen.

- Tap the **Flight Mode** button in Comm Manager. This disables all wireless radios on your device, which include the phone function, Bluetooth, and Wi-Fi.

To resume call function, tap the **Flight Mode** button again in Comm Manager. This also restores the previous state of Bluetooth, but keeps Wi-Fi disabled.

Adjust the device volume

1. Tap the **Speaker** icon (🔊).
2. Under **Volume**, do the following:
 - Adjust the phone volume (📞🔊) or device volume (📱🔊) by moving the slider to the desired volume level.
 - Tap **On** or **Off** to change both the system and ringer volume settings.



Volume adjustment

Note To adjust the conversation phone volume, you must do it during a call. Adjusting the volume at another time will affect the ring, notification, and MP3 sound levels.

3.2 Making a Call

With your device, you can make a call from **Phone**, **Contacts**, **Speed Dial**, **Call History**, and **SIM Manager**.

IMPORTANT You need to have a wired or Bluetooth headset connected to your device to talk to or to hear the other party.

Make a call from Phone

1. Tap **Start > Phone**.
2. On the Phone screen, tap the desired phone number, and tap **Talk**.



Phone screen

Tip If you tap a wrong number, tap the Back arrow () to erase each subsequent digit of a number. To erase the entire number, tap and hold the Back arrow.

Make a call from Contacts

Tap **Start > Contacts**, then do one of the following:

- Tap the desired contact in the contacts list, and tap the phone number that you want to call.
- Tap and hold the desired contact, and on the shortcut menu, tap **Call Work**, **Call Home**, or **Call Mobile**.

To choose one of the numbers of a contact to dial

By default, the mobile telephone number (m) of a contact is dialed when you make a call from Contacts. However, you can specify that a different phone number is dialed instead.

1. Tap **Start > Contacts**.
2. Use the NAVIGATION CONTROL to select a contact.
2. Press NAVIGATION right or left. The letters representing the number will change as you scroll through them.

Make a call from Call History

1. On the Phone screen, tap **Call History**.
2. You can either scroll through all calls in Call History, or tap **Menu > Filter** and select from a category of call types.
3. Scroll to the desired contact or phone number, and tap **Call**.

Make a call from Speed Dial

Use **Speed Dial** to call frequently-used numbers with a single tap. For example, if you assign a contact to the location **2** in Speed Dial, you can simply tap and hold  on the Phone screen to dial the contact's number. Before you can create a Speed Dial entry, the number must already exist in Contacts.

To create a Speed Dial entry

1. On the Phone screen, tap **Speed Dial**.
2. Tap **Menu > New**.
3. Tap a contact. Select the phone number that you want to add to Speed Dial.
4. In the **Location** box, select an available location for the new Speed Dial entry.

Note Location **1** is generally reserved for your voice mail, and Speed Dial will designate the next available location by default. If you want to place a phone number in a position that is already occupied, the new number will replace the number that is already there.

- Tips**
- To create a Speed Dial entry from Contacts, tap and hold the contact name, tap **Add to Speed Dial**, then select the phone number for which to create a Speed Dial and an available location for the new Speed Dial entry.
 - To delete a Speed Dial entry, in the **Speed Dial** list, tap and hold the desired entry, and tap **Delete**.

Make a call from SIM Manager

SIM Manager allows you to view the contents of your SIM card, transfer SIM phonebook entries to Contacts on your device, and make a call from your SIM card.

To call a SIM contact

1. Tap **Start > Programs > SIM Manager**. Wait for your SIM card contents to load.
2. Tap and hold the name or phone number of the person you want to call, and tap **Call**.

3.3 Receiving a Call

When you receive a phone call, a message will appear, giving you the option to either answer or ignore the incoming call.

IMPORTANT You need to have a wired or Bluetooth headset connected to your device to talk to or to hear the other party.

To answer or reject an incoming call

- To answer the call, tap **Answer**.
- To reject the call, tap **Ignore**.

To end a call

Once an incoming or outgoing call is in progress, you can tap **End** on the device to hang up.

3.4 Smart Dialing

Smart Dialing is a program that makes it easy for you to dial a phone number. When you start entering numbers or characters, Smart Dialing will automatically search and sort the contact entries on the SIM card, in Contacts, and the phone numbers in Call History (including incoming, outgoing, and missed calls). You can then select the desired number or contact from the filtered list to dial.

Start Smart Dialing

Open the Phone screen, then tap the keys on the Phone keypad that correspond to the phone number or contact you want to call.

When you start entering a number or letter, the Smart Dialing panel will appear automatically on the Phone screen. You can change the panel size according to your needs by tapping the arrow icon .

Tap to minimize or expand the Smart Dialing panel



Portrait view with minimized Smart Dialing panel



Landscape view with expanded Smart Dialing panel

Tips on using Smart Dialing

Smart Dialing starts looking for numbers or contacts that match the sequence you have entered. Below are some tips on how to use Smart Dialing to quickly find a desired phone number or contact.

To find a phone number

- Simply enter the first one or two digits to find a phone number in Call History.
- Enter the first three digits or more if you want to find a phone number from the saved contacts on your device and SIM card.

To find a contact name

You can just enter the first letter of a contact's first name or surname. Smart Dialing will search for the letter starting from the first character of a contact name as well as from the character that appears after a space, dash, or underscore in a contact name. For example, if you tap number "2" which is associated with [a, b, c] on the Phone keypad, contact names such as the following will be considered matches: "Ben Miller," "George Adams," "John-Carter," "Carter, Ellen," "Dixon, Allan," "Thomas_Clark," "JaneCampbell."

If the matching list is long and you want to narrow down the search further, enter another letter. Using the same example above, if you continue to

tap “3” which is associated with [d, e, f], the matching list will be narrowed down to the following names: “**Ben Miller**,” “**George Adams**,” “**Carter, Ellen**,” “**Dixon, Allan**.”

Make a call or send a text message using Smart Dialing

1. Begin entering the first few numbers or characters.
2. In the Smart Dialing panel, browse the list by tapping the arrows (▲ / ▼) or pressing NAVIGATION up or down to select the desired contact or phone number. When a contact is selected, it expands to also show the corresponding phone number.
3. The highlighted item will move one line when you press NAVIGATION up or down; the highlighted item will scroll one page when you tap the arrows.
4. Do one of the following:
 - When the correct contact is selected, tap **Talk** to make a voice call.
 - To call a different phone number associated with the selected contact, tap and hold the selected contact, and tap the phone number you want to call.





Tap and hold the contact to pop up the shortcut menu

- To send a text message to the selected contact, tap and hold the contact, and tap **Send Text Message**.

Tip To view or edit information associated with the selected contact, tap the contact's name on the shortcut menu (applies only to entries stored in Contacts on your device).

Set up Smart Dialing

1. On the Phone screen, tap **Menu > Smart Dialing Options**.
2. On the **Options** tab, select the **Enable Smart Dialing** check box.
 - Select the **Automatically expand selected contact** check box to enable a contact's name and phone number to be displayed when the contact is selected in the matching list.
 - Select the **Enable drag-scroll** check box to scroll in the matched list by dragging.
 - Select the **Enable double-click for dialing** check box to make a voice call by double-tapping the item in the matched list.
 - Select the **Expand panel when using hardware keyboard** check box to automatically expand the Smart Dialing panel when you are using the hardware keyboard to input.
 - In **Scroll unit**, you can set the amount of scrolling when tapping the arrows ( / ).

3.5 In-call Options

To put a call on hold

Your device notifies you when you have another incoming call, and gives you the choice of rejecting or accepting the call. If you are already on a call and accept the new call, you can choose to switch between the two callers, or set up a conference call between all three parties.

1. Tap **Answer** to take the second call, and put the first one on hold.
2. To end the second call and return to the first call, tap **End** on the device.

To switch between two calls

- Tap **Swap**.

To set up a conference call

1. Either put a call on hold, and dial a second number; or, accept a second incoming call when you already have one in progress.
2. Tap **Conference**.

Note Not all service providers support conference calling. Contact your service provider for details.

To mute a call

You can turn off the microphone during a call, so that you can hear the caller but the caller cannot hear you.

- During a call, tap **Mute**.
- When the microphone is turned off, the mute icon () appears on the screen. Tap **Unmute** to turn on the microphone again.

3.6 Additional Dialing Information

Make an emergency call

- Enter the international emergency number for your locale, and tap **Talk**.

Tip Additional emergency numbers may be included in your SIM card. Contact your service provider for details.

Make an international call

1. Tap and hold  on the Phone keypad until the + sign appears. The + replaces the international prefix of the country that you are calling.
2. Enter the full phone number you want to dial, and tap **Talk**. The full phone number includes country code, area code (without the leading zero, if any) and phone number.

3.7 Setting Up Bluetooth SIM Access for Car Kit Phones

Car kit phones that support the SIM Access Profile (SAP) can connect to your device and access its SIM card via Bluetooth. Once a SAP connection has been established, you can download SIM contacts from your device to the car kit phone. You can also use the car kit phone to answer and make calls using your device's SIM card.

- Notes**
- To enable downloading contacts onto the car kit, ensure that all contacts on the device are stored in the SIM card and not in the device memory. Configure the car kit to download contacts only from the SIM card.
 - Contact your wireless service provider to find out which car kit phone models are compatible with your device.
1. On your device, make sure that Bluetooth is turned on and set to visible mode. For information about turning on Bluetooth and enabling visible mode, see “Bluetooth modes” in Chapter 9.
 2. Tap **Start > Programs > SAPSettings**.
 3. On the BT Remote SIM Access screen, select the **Remote SIM Access** check box then tap **Done**.
 4. Connect the car kit phone to your device via Bluetooth. To learn how to connect, consult your car kit phone's manual.
 5. If this is the first time you are pairing the car kit phone with your device, enter the car kit's passcode on your device.
 6. A pop-up message should appear on your device saying that a connection has been established between your device and car kit phone. Tap **OK**.
 7. On the BT Remote SIM Access screen, tap **Done**.

Note You will not be able to make/receive calls, send/receive messages or perform related activities on your device when the SIM Access Profile connection is active. You'll be able to do all these from the car kit phone during this time. After the connection is disconnected, you will be able to use your device as before.

Chapter 4

Setting Up Your PDA Phone

4.1 Basic Settings

4.2 Personalizing the Today Screen

4.3 Customizing Phone Settings and Services

4.4 Protecting Your Device

4.5 Other Settings

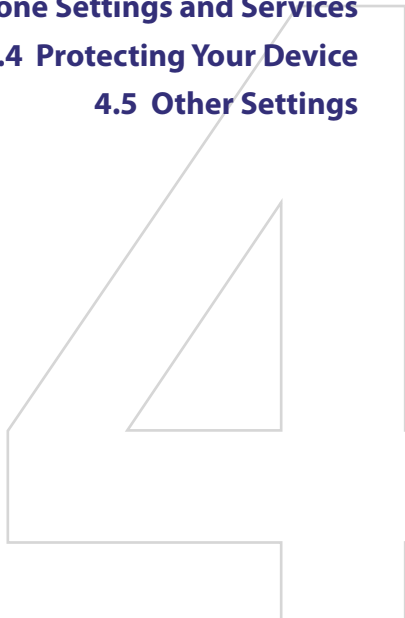

4.1 Basic Settings

Owner information

Having owner information displayed on the Today screen makes it easier for someone to return your device to you if it is lost.

To enter owner information

1. Tap **Start > Settings > Personal tab > Owner Information**.
2. On the **Identification** tab, enter your personal information.

Tip If you don't see owner information on the Today screen, tap **Start > Settings > Personal tab > Today**. On the **Items** tab, select the **Owner Info** check box.

To display owner information when the device is turned on

You can set your device to display the 'my info' screen when power is turned on. This screen shows your complete personal information.

1. Tap **Start > Settings > Personal tab > Owner Information**.
2. On the **Options** tab, select the **Identification information** check box.
3. If you want additional text displayed, tap the **Notes** tab and enter the text (for instance: Reward if found).
4. On the **Options** tab, select the **Notes** check box then tap **OK**.

Time and date

To set the time and date

1. Tap **Start > Settings > System tab > Clock & Alarms > Time** tab.
2. Select the correct time zone and change the date or time.

Note During synchronization, the time on your device is updated with the time on your PC. For information about synchronizing with the PC, see Chapter 5.

To set the time and date for a different location

If you visit or communicate with someone in a particular time zone often, you can select it as your visiting time zone.

1. Tap **Start > Settings > System tab > Clock & Alarms > Time** tab.
2. Tap **Visiting**.
3. Select the correct time zone and change the time or date.

Regional settings

The style in which numbers, currency, dates, and times are displayed is specified in regional settings.

1. Tap **Start > Settings > System tab > Regional Settings**.
2. On the **Region** tab, select your region from the list.
Note This does not change the Operating System language of your device.
3. The region you select determines which options will be available on the other tabs.
4. To customize settings further, tap the appropriate tabs and select the desired options.

4.2 Personalizing the Today Screen

The Today screen shows your upcoming appointments, active tasks, and information about incoming messages. You can customize what to display on the Today screen.

To customize the Today screen

1. Tap **Start > Settings > Personal tab > Today**.
2. On the **Appearance** tab, select the desired theme for the background of the Today screen.
3. On the **Items** tab, select the items you want to appear on the Today screen.

Tip To change the order of items displayed on the Today screen, tap the item, and tap **Move Up** or **Move Down**.

To use a custom background image

You can use one of your own pictures as the background image on the Today screen. Be aware that pictures can affect the readability of text on the Today screen.

1. Tap **Start > Settings > Personal tab > Today**.
2. Select the **Use this picture as the background** check box, and tap **Browse** to view a list of your picture files.

3. Tap the file name of the picture you want to use.
4. Tap **OK**.

To set options for displaying appointments on the Today screen

If you have a large number of appointments, you may want to specify the kind of appointments that are displayed on the Today screen.

1. Tap **Start > Settings > Personal tab > Today**.
2. Tap the **Items** tab.
3. Select **Calendar** and tap **Options**.
4. Do any of the following:
 - Select **Next appointment** to show only the next appointment in your schedule, or **Upcoming appointments** to show multiple appointments.
 - Clear the **Display all day events** check box if you do not want to display all-day events.

For more information about using Calendar, see Chapter 6.

To set options for displaying tasks on the Today screen

If you have a large number of tasks, you may want to specify the kind of tasks that are displayed on the Today screen.

1. Tap **Start > Settings > Personal tab > Today**.
2. Tap the **Items** tab.
3. Select **Tasks** and tap **Options**.
4. Do any of the following:
 - Under **Display number of**, select the type of tasks you want to appear on the Today screen.
 - In the **Category** list, select whether to display only tasks assigned to a specific category or to display all tasks.

For more information about creating tasks on your device, see Chapter 6.

Customize the Start menu

You can choose which items appear in the **Start** menu.

1. Tap **Start > Settings > Personal tab > Menus**.
2. Select the check boxes of the items you want to appear in the **Start** menu. You can select up to seven items.

Tip You can also create folders and shortcuts to appear on the Start menu. Using Windows Explorer on your PC, navigate to the **/Windows/Start Menu** folder of your device, then create the folders and shortcuts that you want. You will see the added items on your device after you synchronize. For information about synchronizing your device with the computer, see Chapter 5.

4.3 Customizing Phone Settings and Services

You can customize phone settings, such as the ring type and ring tone to be used for incoming calls, and the keypad tone to be used when entering phone numbers. You can also set up your device to use phone services such as Call Waiting, Call Forwarding, and more.

To access phone settings and services

- Tap **Menu > Options** on the Phone screen; or
- Tap **Start > Settings > Personal tab > Phone**.

Ring tone settings

To change the ring tone and ring type

1. On the Phone screen, tap **Menu > Options > Phone** tab.
2. In the **Ring tone** list, tap the sound you want to use.

Note You can use ***.wav**, ***.mid**, ***.mp3**, or ***.wma** files that you downloaded from the Internet or copied from your PC as ring tones. Copy the sound files first to the **/Windows/Rings** folder on your device, then select the sound from the Ring tone list of your device. For more information about copying files, see Chapter 14.

3. In the **Ring type** list, choose whether to be notified of incoming calls by a ring, a vibration, or a combination of both.

Keypad tone

You can change the tone you hear when entering a phone number on the keypad. If set to Long tones, the tone is heard continuously for as long as the number on the keypad is pressed. Use this setting if you are having trouble accomplishing tasks that rely on tones from your device such as accessing messages from an answering machine. If set to Short tones, the tone is heard only for one or two seconds. If set to Off, no tone will be heard.

1. On the Phone screen, tap **Menu > Options > Phone** tab.
2. In the **Keypad** list, tap the option you want.

Phone services

Your device can directly link to the mobile phone network, and allow you to access and change the settings of various phone services for your device. Phone services may include Call Forwarding, Call Waiting, Voicemail, and more. Contact your wireless service provider to find out about the availability of phone services for your device.

To access and change settings of phone services

1. Tap **Start > Settings > Personal** tab > **Phone > Services** tab.
2. Select the service you want to use, then tap **Get Settings**.
3. Choose your desired options, then tap **OK**.

For more information about customizing settings of phone services, see **Help** on your device.

4.4 Protecting Your Device

There are two kinds of protection that you can set for your device:

- You can protect your SIM card from unauthorized use by assigning a PIN (personal identification number). Your first PIN will be given to you by your wireless service provider; you can change the PIN later.
- Additionally, you can prevent unauthorized access to any part of the device by using password protection. You can help keep your data more secure by requiring a password every time the device is turned on. You create your own password when you begin using your device.

To protect your SIM card with a PIN

1. On the Phone screen, tap **Menu > Options > Phone** tab.
2. Select the **Require PIN when phone is used** check box.
3. To change the PIN at any time, tap **Change PIN**.

Tip Emergency calls can be placed at any time, without requiring a PIN.

To protect your device with a password

1. Tap **Start > Settings > Personal** tab > **Lock**.
2. Select the **Prompt if device unused for** check box, and in the box to the right, select how long your device must be idle before a password is required. In the **Password type** box, select the type of password you would like to use. Enter the password and, if necessary, confirm the password.
If your device is configured to connect to a network, use an alphanumeric password for increased security for your device.
3. On the Hint tab, enter a phrase that will help you remember your password, but does not allow others to guess your password. The hint will be displayed after the wrong password is entered four times.
4. Tap **OK**. The next time the device is turned on, you will be prompted to enter your password.

- Notes**
- Each time a wrong password is entered, the device response time gets longer until the device appears to be not responding.
 - If you forget your password, you must follow the instructions in this user manual to clear the memory before you can access your device.

To change your password

1. Tap **Start > Settings > Personal tab > Lock**. You will be prompted to enter your current password.
2. In the **Password** box, enter your new password.
3. On the **Hint** tab, enter a phrase that will help you remember your new password, but does not allow others to guess your password. The hint will be displayed after the wrong password is entered four times.
4. Tap **OK**.

4.5 Other Settings

Device name

The device name is used to identify the device in the following situations:

- Synchronizing with a PC
- Connecting to a network
- Restoring information from a backup

Note If you synchronize multiple devices with the same PC, each device must have a unique name. For information about synchronizing with your PC, see Chapter 5.

To change the device name

1. Tap **Start > Settings > System tab > About**.
2. Tap the **Device ID** tab.
3. Enter a name.

Note The device name must begin with a letter, consist of letters from **A** to **Z**, numbers from **0** to **9**, and cannot contain spaces. Use the underscore character to separate words.

Display settings

To adjust the brightness of the backlight

1. Tap the battery icon () on the Today screen.
2. On the Power settings screen, tap **Menu > Backlight**.

3. On the **Brightness** tab, move the slider right to increase the brightness, or left to decrease the brightness.

To set the backlight to dim after a time delay

1. Tap the battery icon () on the Today screen.
2. On the Power settings screen, tap **Menu > Backlight**.
3. Tap the **Battery power** tab, or the **External power** tab.
4. Select the **Turn off backlight if device is not used for** check box, and specify the time delay.

Note For more information about adjusting display settings to save battery power, see "Battery Saving Tips" in Chapter 14.



To increase or decrease the size of text on the screen

1. Tap **Start > Settings > System** tab > **Screen > Text Size** tab.
2. Move the slider to increase or decrease the text size.

Button settings

To configure the button using Task Manager

You can configure the  button to shut down running programs and free up the memory space that's occupied by them.

1. Tap **Start > Settings > System** tab > **Task Manager**.
2. On the **Button** tab, select the **Enable the "X" button to end running programs** check box.
3. Choose the action for shutting down programs (by tapping the  button, tapping and holding the  button, or both).
4. Tap **OK**.

Note When the Enable the "X" button to end running programs check box is not selected, tapping the  button will only close a program screen. The program is not ended and continues to run in the background.

To reassign programs or shortcuts to program buttons

Your device may come with programs already assigned to hardware buttons. You can customize these buttons to open the programs you use most, or to perform certain shortcuts such as changing the screen orientation, opening the Today screen, or opening Input Panel.

1. Tap **Start > Settings > Personal tab > Buttons**.
2. A list of buttons and their current assignments are displayed on the **Program Buttons** tab.
3. Tap the button you want to reassign. To help you identify the buttons, there are numbers and icons representing the original function of the button.
4. In the **Assign a program** box, tap the program or shortcut you want to assign.
5. Tap **OK**.

Word completion options

Word completion helps you enter text faster by suggesting words as you enter letters using the on-screen keyboard or the handwriting recognition methods. You can set the number of suggested words to display, when to show the word list, and more.

1. Tap **Start > Settings > Personal tab > Input > Word Completion** tab.
2. Make sure the **Suggest words when entering text** check box is selected.
3. By default, the suggested word list appears whenever you enter a space. To make the word list appear after letters are entered, select the number of letters that you want to be entered before displaying the word list.
4. The suggested word list shows up to four words by default. You can change the number of words to display in the suggested list.
5. Make sure the **Enable Auto Correct** check box is selected if you want mistyped words to be corrected automatically.

Alarms and notifications

To set an alarm

1. Tap **Start** > **Settings** > **Systems** tab > **Clock & Alarms** > **Alarms** tab.
2. Tap <**Description**> and enter a name for the alarm.
3. Tap the day of the week for the alarm. You can select multiple days by tapping each desired day.
4. Tap the time to open a clock and set the time for the alarm.
5. Tap the alarm icon (🔔) to specify the type of alarm you want. You can choose a flashing light, a single sound, or a repeating sound,.
6. If you choose to play a sound, tap the list next to the **Play sound** check box and tap the sound you want.

To choose how to be notified about events or actions

1. Tap **Start** > **Settings** > **Personal** tab > **Sounds & Notifications**.
2. On the **Sounds** tab, choose how you want to be notified by selecting the appropriate check boxes.
3. On the **Notifications** tab, in **Event**, tap an event name and choose how you want to be notified by selecting the appropriate check boxes. You can choose from several options, such as a special sound, a message, or a flashing light.

Tip Turning off sounds and the flashing light helps conserve battery power.

TV Out setting

To use TV Out

TV Out lets you output the contents you are viewing on the device screen to an external display device (e.g. projector). This is useful when you are doing a presentation or when you are sharing your videos or photos with people.

To connect the device to an external display device

1. Turn off the external viewing device and unplug the power cord from the wall socket.
2. Take out the VGA cable from the box. Connect the external viewing device's cable to the bigger end of the VGA cable.

72 Setting Up Your PDA Phone

3. Connect the smaller end of the VGA cable to the VGA port on the device.
4. Plug in the power cable of the external viewing device to a wall socket and turn it on.

To enable TV Out

1. On the Today screen, tap **Start > Settings > System** tab > **TV Out**.
2. On the **TV Out** Settings screen, choose **On** on the drop-down menu.
3. Choose the **Connection** that you are using to output.
 - Select **VGA-out** if you are doing a presentation such as a Powerpoint presentation and you are outputting it to a projector.
 - Select **Composite & S-Video** if you are going to output a video to the external viewing device. Choose the Video standard to use when outputting (e.g. If your video is in the NTSC video standard and you select PAL, TV Out will convert your video to PAL before outputting.)
4. Tap **OK**.

Note Audio output is supported.

To disable TV Out

1. On the Today screen, tap **Start > Settings > System** tab > **TV Out**.
2. On the **TV Out** Settings screen, choose **Off** on the drop-down menu.
3. Turn off the external viewing device and then unplug the power cord.
4. Disconnect the VGA cable's smaller end from the device and then disconnect the external viewing device's cable from the VGA out cable.

The Microdrive

To format the Microdrive

Your device comes with a built-in 8GB Microdrive® that gives you additional storage space for your files. Use Format Microdrive to delete all the files in the Microdrive and to format it.

1. Tap **Start > Settings > Systems** tab > **Format Microdrive**.
2. Enter **1234** in the box and tap **Continue**.

Chapter 5

Synchronizing Information With Your Computer

5.1 About ActiveSync

**5.2 Setting Up Microsoft Windows Mobile®
Device Center on Windows Vista**

**5.3 Setting Up Microsoft ActiveSync®
on Windows XP**

5.4 Synchronizing with Your Computer

5.5 Synchronizing via Bluetooth

5.6 Synchronizing Music and Video

5.1 About ActiveSync

You can take information from your computer wherever you go by synchronizing them to your device. The following types of information can be synchronized between your computer and your device:

- **Microsoft Outlook®** information, which include Outlook e-mail, contacts, calendar, tasks, and notes.
- **Media**, such as pictures, music and video.
- **Favorites**, which are the bookmarked links to your favourite Web sites.
- **Files**, such as documents and other files.

Before you can synchronize, you need to install first the synchronization software to your computer. For more information, see “Setting Up Windows Mobile Device Center” if you are using Windows Vista™, or see “Setting Up ActiveSync” if you are using Windows XP®.

Ways to synchronize

After you have installed the synchronization software to your computer, connect and synchronize your device with your computer by using one of the following methods:

- Connect and synchronize using the supplied USB sync cable. Upon connecting the sync cable to your device and your computer, the synchronization process starts automatically.
- Connect and synchronize using Bluetooth. You must first set up a Bluetooth partnership between your device and your computer before you can synchronize information through Bluetooth. For more information about setting up a Bluetooth partnership, see Chapter 9. For information about synchronizing through Bluetooth, see “Synchronizing via Bluetooth” later in this chapter.

Try to synchronize frequently in order to keep information up to date in both your device and your computer.

Note You can also synchronize Outlook e-mail, contacts, calendar, and tasks on your device with the Exchange Server at your work. For more information about setting up your device to synchronize with the Exchange Server, see Chapter 8.

5.2 Setting Up Microsoft Windows Mobile® Device Center on Windows Vista

Microsoft Windows Mobile® Device Center is the replacement for Microsoft® ActiveSync® on Windows Vista™.

Note Some versions of Windows Vista come with Windows Mobile Device Center already installed. If Windows Mobile Device Center is not available on your Windows Vista, you can install it from the Getting Started Disc that came with your device.

Set up synchronization

1. Connect your device to your PC. Windows Mobile Device Center configures itself and then opens.
2. On the license agreement screen, click **Accept**.
3. On the Windows Mobile Device Center's Home screen, click **Set up your device**.

Note Choose **Connect without setting up your device** if you only want to transfer media files, check for updates, and explore your device but not sync Outlook information.

4. Select the information types that you want to synchronize then click **Next**.
5. Enter a device name and click **Set Up**.

When you finish the setup wizard, Windows Mobile Device Center synchronizes your device automatically. Notice that Outlook e-mails and other information will appear on your device after synchronization.

Use Windows Mobile Device Center

To open Windows Mobile Device Center, click **Start > All Programs > Windows Mobile Device Center** on your Windows Vista computer. On Windows Mobile Device Center, you can do the following:

- Click **Mobile Device Settings** to view and change synchronization settings.
- When you click **Pictures, Music and Video > Import pictures/video from your device**, a wizard guides you to tag and transfer photos from your device to the Photo Gallery on your Windows Vista PC.

- Click **Pictures, Music and Video > Add media to your device** to synchronize music and video files using Windows Media™ Player. For more information, see “Using Windows Media Player Mobile” in Chapter 12.
- Click **File Management > Browse the contents of your device** to view documents and files from your device.

Note See Windows Mobile Device Center Help for more information.

5.3 Setting Up Microsoft ActiveSync® on Windows XP

The Getting Started Disc that comes with your device contains Microsoft ActiveSync 4.5 or later. Follow the steps below to install and set up ActiveSync 4.5 or higher on Windows XP or other compatible Windows systems.

Note For a list of compatible Windows systems, please go to:
<http://www.microsoft.com/windowsmobile/activesync/activesync45.msp.x>.

Install ActiveSync

1. Insert the Getting Started Disc into the disc drive on your PC.
2. ActiveSync is available in English and several other languages. Select the desired language then click **Next**.
3. Click **Setup and Installation**.
4. Select the **ActiveSync** check box and click **Install**.
5. Read the license terms and click **Accept**.
6. When installation is complete, click **Done**.
7. On the Getting Started with Windows Mobile screen, click **Close**.

Set up synchronization

Follow the steps below to set up a synchronization partnership.

1. Connect your device to your PC. The Synchronization Setup Wizard automatically starts and guides you to create a synchronization partnership. Click **Next** to proceed.

2. To synchronize your device with your PC, clear the **Synchronize directly with a server running Microsoft Exchange** check box then click **Next**.
3. Select the information types that you want to synchronize then click **Next**.
4. Select or clear the **Allow wireless data connections** check box according to your preference.
5. Click **Finish**.

When you finish the wizard, ActiveSync synchronizes your device automatically. Notice that Outlook e-mails and other information will appear on your device after synchronization.

5.4 Synchronizing with Your Computer

Connect your device to the PC using the USB cable or Bluetooth connection. Windows Mobile Device Center or ActiveSync then opens and lets you synchronize.

Note If you are synchronizing directly with Exchange Server, you can use this connection to the PC to “pass through” to the network, or you can synchronize without connecting to the PC over a cellular network. For more information on synchronizing with the Exchange Server, see Chapter 8.



Start and stop synchronization

You can manually synchronize either from your device or PC.

From your device



1. Tap **Start > Programs > ActiveSync**.
2. Tap **Sync**.
3. To end synchronization before it completes, tap **Stop**.

From Windows Mobile Device Center

1. Click **Start > Windows Mobile Device Center**.
2. Click  at the lower left of the Windows Mobile Device Center.
3. To end synchronization before it completes, click .

From ActiveSync on your PC

When you connect your device to your PC, ActiveSync automatically opens on your PC and synchronizes.

1. To manually start synchronization, click .
2. To end synchronization before it completes, click .

Change which information is synchronized

You can change the information types and the amount of information to synchronize for each type either from your device or your PC. Follow the steps below to change synchronization settings from your device.

Note Before changing synchronization settings on your device, disconnect it from your PC.

1. In ActiveSync on your device, tap **Menu > Options**.
2. Select the check box for any items you want to synchronize. If you cannot select a check box, you might have to clear the check box for the same information type elsewhere in the list.
3. To change synchronization settings for an information type, for instance, **E-mail**, select it and tap **Settings**.
You can then set the download size limit, specify the time period of information to download, and more.

- Notes**
- Some information types such as Favorites, Files and Media cannot be selected in ActiveSync Options on your device. You can only select or clear these items from your PC's Windows Mobile Device Center or ActiveSync.
 - A PC can have sync partnerships with many different Windows Mobile powered devices, but a device can have sync partnerships with at most two PCs only. To ensure that your device will synchronize properly with both PCs, set up the second PC using the same synchronization settings you used on the first PC.
 - Outlook e-mail can be synchronized with only one computer.

Sync connection problem

The desktop Microsoft ActiveSync 4.0 and later versions utilize a network type of connection with Windows Mobile powered devices, since this allows faster data transfer than a serial USB connection. When the PC is connected to the Internet or a local network, in some cases, the PC may disconnect the connection with your device in favor of the Internet or network connection.

If this happens, tap **Start > Settings > Connections** tab > **USB to PC**, then clear the **Enable advanced network functionality** check box. This makes your PC utilize a serial USB connection with your device.

The **USB to PC** () icon appears on the Today Screen when serial USB connection is used.

5.5 Synchronizing via Bluetooth

You can connect your device to the PC to synchronize using Bluetooth.

1. Follow the instructions in Windows Mobile Device Center Help or ActiveSync Help on the computer for setting up a Bluetooth connection on your computer.
2. On your device, tap **Start > Programs > ActiveSync**.
3. Tap **Menu > Connect via Bluetooth**. Make sure the Bluetooth function of both your device and the computer are turned on and set to visible mode.
4. If this is the first time you have connected to this computer via Bluetooth, you must first complete the Bluetooth wizard on your device and set up a Bluetooth partnership between your device and the computer. For more information about creating a Bluetooth partnership, see “Bluetooth partnerships” in Chapter 9.

- Notes**
- To preserve battery power, turn off Bluetooth when not in use.
 - To connect and synchronize your device with a computer via Bluetooth, your computer must have built-in Bluetooth or installed with a Bluetooth adapter or dongle.

5.6 Synchronizing Music and Video

If you want to carry your music or other digital media along with you while you travel, set up Microsoft Windows Media Player on your computer to synchronize music and video with your device.

Other than selecting the Media information type to be synchronized, all media synchronization settings must be set in Windows Media Player.

Before media can be synchronized, you must do the following:

- Install Windows Media Player Version 11 on the PC. (Windows Media Player 11 works only in Windows XP or later versions).
- Connect your device to the PC with a USB cable. If your device is currently connected using Bluetooth, you must end that connection before media can be synchronized.
- Set up a sync partnership between your device and your PC's Windows Media Player.

For more information about Windows Media Player on your device, see “Using Windows Media Player” in Chapter 12.

Chapter 6

Organizing Contacts, Appointments, Tasks, and Other Information

6.1 Contacts

6.2 SIM Manager

6.3 Calendar

6.4 Tasks

6.5 Notes

6.6 Voice Recorder

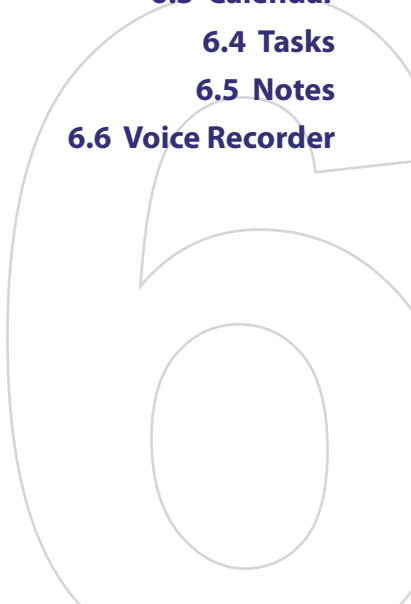

6.1 Contacts

Contacts is your address book and information storage for the people and businesses you communicate with. Store phone numbers, e-mail addresses, home addresses, and any other information that relates to a contact, such as a birthday or an anniversary date. You can also add a picture or assign a ring tone to a contact.

From the contact list, you can quickly communicate with people. Tap a contact in the list for a summary of contact information. From there, you can call or send a message.

There are two types of contacts that you can create on your device:

- **Outlook contacts.** Contacts that are stored on your device, which can be created on your device or synchronized with your PC or the Exchange Server. For each contact, you can store phone numbers, e-mail addresses, instant messaging (IM) names, company and home addresses, and information such as a job title, birthday, and a lot more. You can also add a picture and assign a ring tone to an Outlook contact.
- **SIM contacts.** Contacts that are stored on the SIM card. Only the name and a phone number can be stored for each entry.

Tip If you use Outlook on your PC, you can synchronize contacts between your device and PC.

To add a contact on your device

1. Tap **Start > Contacts**.
2. Tap **New**, select **Outlook Contact**, and enter the contact information.
3. In the **File as** field, choose how you want the contact name to appear in the contact list.
4. To add a photo of the contact, tap **Select a picture**, then select the picture file or tap **Camera** to take a photo of the contact. This photo appears on the Phone screen when you receive a call from the contact.
5. To assign a ring tone to the contact, tap the **Ring tone** field, scroll through the list of tones, then select a desired tone.
6. When finished, tap **OK**.

- Tips**
- If someone who is not in your list of contacts calls you, you can create a contact from Call History by tapping and holding a phone number and then tapping **Save to Contacts** from the shortcut menu.
 - To save a phone number that is contained in a message, tap the phone number, then tap **Menu > Save to Contacts**.
 - In the list of contact information, you'll see where you can add a picture or assign a ring tone to a contact.

To change contact information

1. Tap **Start > Contacts**.
2. Tap the contact.
3. Tap **Menu > Edit** and enter the changes.
4. When finished, tap **OK**.

Organize and search

To group similar contacts

You can group similar contacts for easier management by assigning them to categories.

1. Create a new contact, or select an existing contact to edit.
2. Tap **Categories**.
3. Select a preset category such as Business or Personal, or tap **New** to create your own category.
4. When finished, tap **OK**.

Note If your contact list has been filtered by a category, that category is automatically assigned when you create a new contact.

To work with the contact list

There are several ways to use and customize the contact list. Here are a few tips:

1. Tap **Start > Contacts**.
2. In the contact list, do any of the following:
 - In Name view, you can search for a contact by entering a name or number, or by using the alphabetical index. To switch to Name view, tap **Menu > View By > Name**.

- To see a summary of information about a contact, tap the contact. From there you can also make a call or send a message.
- To see a list of available actions for a contact, tap and hold the contact.
- To see a list of contacts employed by a specific company, tap **Menu > View By > Company**, then tap the company name.

To find a contact on your device

There are several ways to find a contact when your contact list is long.

1. Tap **Start > Contacts**.
2. If you are not in Name view, tap **Menu > View By > Name**.
3. Do one of the following:
 - Begin entering a name or phone number in the provided text box until the contact you want is displayed. To show all contacts again, tap the text box and clear the text, or tap the arrow to the right of the text box.
 - Use the alphabetical index displayed at the top of the contact list.
 - Filter the list by categories. In the contact list, tap **Menu > Filter**, then tap a category you've assigned to a contact. To show all contacts again, select **All Contacts**.

Share contact information

To beam a contact's details

You can quickly send contact information to another mobile phone or device through Bluetooth beaming.

1. Tap **Start > Contacts**, then select a contact.
2. Tap **Menu > Send Contact > Beam**.
3. Select a device where to beam the contact to.

Note Before you can beam, make sure Bluetooth is turned on and set to discoverable mode on your device and the target mobile device. You can also beam contact information to your PC. For more information, see "Using Bluetooth" in Chapter 9.

To send contact information via text messaging

1. Tap **Start > Contacts**, then select a contact.
2. Tap **Menu > Send Contact > Text Message**.
3. Select the contact information you want to send, then tap **Done**.
4. In the new text message, enter the mobile phone number of the recipient, then tap **Send**.

To send contact information as a vCard

A vCard (virtual business card) is a standard file format used for exchanging contact information. vCard files can be exported to Outlook on the PC. From your device, you can send a vcard containing contact information as a file attachment in an MMS message.

1. Tap **Start > Contacts**, then select a contact.
2. Tap **Menu > Send as vCard**.
3. A new MMS message is created with the vcard file attached. Enter the mobile phone number or e-mail address of the recipient then tap **Send**.

For more information about sending MMS messages, see “MMS Messages” in Chapter 7.

6.2 SIM Manager

SIM Manager allows you to view the contents of your SIM card, transfer contacts from your SIM card to your device or vice versa, and make a call to a SIM contact.

To add a contact on your SIM card

1. Tap **Start > Programs > SIM Manager**. This opens the SIM Manager program.
2. Tap **New** and enter a contact name and phone number.
3. Tap **Save** to save the information on your SIM card.

Tip To change contact information on your SIM card, tap **Start > Programs > SIM Manager**, then tap a SIM contact and edit it. After modifying, tap **Save**.

To copy SIM contacts to your device

If you have saved contacts on your SIM card, you can copy them into Contacts on your device.

1. Tap **Start > Programs > SIM Manager**.
2. Select the desired item, or select all SIM contacts by tapping **Menu > Select All**.
3. Tap **Menu > Save to Contacts**.

To copy contacts to the SIM card

Only one phone number per contact name can be stored on a SIM card.

When you copy a contact that has several phone numbers to your SIM card, SIM Manager saves each number under a separate name.

To save each number under a different contact name on the SIM card, SIM Manager appends an indicator at the end of each name. By default, /M, /W and /H are appended to indicate mobile, work and home phone numbers respectively. You can edit this indicator first before you start copying contacts to your SIM card. Indicators of the other types of phone numbers are left empty for you to define them.

1. Tap **Start > Programs > SIM Manager**, then tap **Menu > Tools > Options**.
2. On the Options screen, select the check boxes of the types of phone numbers that you want to be added to the SIM card.

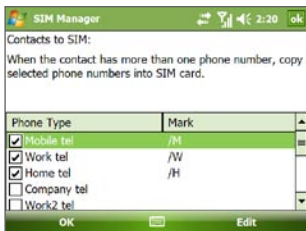

3. Under the **Mark** column, you can change the indicator that will be appended to the SIM contact names for each phone number type. To do so, select a phone type, tap **Edit**, enter your desired indicator, then tap **Save**.

4. After modifying, tap **OK**.
5. Tap **Menu > Contacts to SIM**.
6. Select the check boxes of the contact's phone numbers that you want to copy to your SIM card, then tap **Save**.

To store the SIM card's phone number

If you have saved contacts on your SIM card, you can copy them into Contacts on your device.

1. On the SIM Manager screen, tap **Menu > Tools > List of Own Numbers**.
2. Tap **Voice Line 1**.
3. Change the name, if desired, then enter your mobile phone number.
4. Tap **Save**. When your phone number is stored on the SIM card, it will show on the SIM Manager screen.

6.3 Calendar

Use **Calendar** to schedule appointments, including meetings and other events. Your appointments for the day can be displayed on the Today screen. If you use Outlook on your PC, you can synchronize appointments between your device and PC. You can also set Calendar to remind you of appointments with a sound or flashing light, for example.

You can look at your appointments in several different views (Day, Week, Month, Year, and Agenda). To see detailed appointment information in any view, tap the appointment.

Create appointments

To schedule an appointment

1. Tap **Start > Calendar**.
2. Tap **Menu > New Appointment**.
3. Enter a name for the appointment
4. Do one of the following:

- If it is a special occasion such as a birthday or a whole-day event, set the **All Day** option to **Yes**.
 - If there is a time frame for the appointment, select the start and end dates and time.
5. Specify the type of category for your appointment, so that it can be grouped with other related appointments. Tap **Categories**, then select a preset category (Business, Holiday, Personal, or Seasonal), or tap **New** to create your own category.
 6. When finished, tap **OK** to return to the calendar.

- Notes**
- All-day events do not occupy blocks of time in Calendar; instead, they appear in banners at the top of the calendar.
 - To cancel an appointment, tap the appointment and tap **Menu > Delete Appointment**.





Tip To have the time entered automatically in Day view, tap the time slot for the new appointment, and tap **Menu > New Appointment**.

View appointments

By default, Calendar displays appointments in **Agenda** view. You can also look at your appointments in **Day**, **Week**, **Month**, and **Year** views.



- To see detailed appointment information in any view, tap the appointment.
- To view appointments by category, tap **Menu > Filter** then select the desired category.

- To change the default view that Calendar uses to display appointments, tap **Menu > Tools > Options > General** tab. Tap the **Start in** box then choose the calendar view.
- When in **Month** view, you will see the following indicators:
 -  Morning appointment
 -  Afternoon or evening appointment
 -  Both morning and afternoon/evening appointments
 -  All-day event

Send appointments

To send a meeting request

Use Calendar to schedule meetings via e-mail with contacts who use Outlook or Outlook Mobile.

1. Tap **Start > Calendar**.
2. Schedule a new appointment, or open an existing one and tap **Edit**.
3. Tap **Attendees**.

Note You can specify if an attendee is required or optional only if your device is connected to a Microsoft Exchange 2007 server. Otherwise, all attendees are designated as required. For more information, see Chapter 8.
4. Tap the name of the contact you want to invite.
5. To invite each additional attendee, tap **Add** and tap the name.
6. Tap **OK** to send.

Tip To choose the e-mail account to use for sending meeting requests, tap **Menu > Tools > Options > Appointments** tab. Tap the Send meeting requests via box and choose to send via your Outlook E-mail, POP3/IMAP4 or Windows Live account.

- Notes**
- If you're sending the meeting request using your Outlook E-mail account, it will be sent to the attendees the next time you synchronize your device with your PC or Exchange Server.
 - When attendees accept your meeting request, the meeting is automatically added to their schedules. When their response is sent back to you, your calendar is updated as well.

To send appointment details as a vCalendar

A vCalendar is a standard file format used for exchanging scheduling and task information. vCalendar files can be exported to Outlook on the PC.

Tap **Menu > Send as vCalendar** to send a vCalendar containing appointment details as a file attachment in an MMS message. For more information about sending MMS messages, see “MMS Messages” in Chapter 7.

6.4 Tasks

Use **Tasks** to keep track of things you need to do. A task can occur once or repeatedly (recurring). You can set reminders for your tasks and you can organize them using categories.

Your tasks are displayed in a task list. Overdue tasks are displayed in red.

To create a task

1. Tap **Start > Programs > Tasks**.
2. Tap **Menu > New Task**, enter a subject for the task, and fill in information such as start and due dates, priority, and so on.
3. Specify the type of category for your task, so that it can be grouped with other related tasks. Tap **Categories**, then select a preset category (Business, Holiday, Personal, or Seasonal), or tap **New** to create your own category.
4. When finished, tap **OK**.

Tip You can easily create a short, to-do type task. Simply tap the **Tap here to add a new task** box, enter a subject, and tap the Enter button on the on-screen keyboard. If the task entry box is not available, tap **Menu > Options** and select the **Show Tasks entry bar** check box.

To change the priority of a task

Before you can sort tasks by priority, you need to specify a priority level for each task.

1. Tap **Start > Programs > Tasks**.
2. Tap the task you want to change the priority for.

3. Tap **Edit**, and in the **Priority** box, tap a priority level.
4. Tap **OK** to return to the task list.

Note All new tasks are assigned a Normal priority by default.

To set a default reminder for all new tasks

You can have a reminder automatically turned on for all new tasks you create.

1. Tap **Start > Programs > Tasks**.
2. Tap **Menu > Options**.
3. Select the **Set reminders for new items** check box.
4. Tap **OK** to return to the task list.

Note The new tasks must have due dates set in order for the reminder to take effect.

To show start and due dates in the task list

1. Tap **Start > Programs > Tasks**.
2. Tap **Menu > Options**.
3. Select the **Show start and due dates** check box.
4. Tap **OK**.

To locate a task

When your list of tasks is long, you can display a subset of the tasks or sort the list to quickly find a specific task.

1. Tap **Start > Programs > Tasks**.
2. In the task list, do one of the following:
 - Sort the list. Tap **Menu > Sort By**, and tap a sort option.
 - Filter the list by category. Tap **Menu > Filter**, and tap the category you want displayed.

Tip To filter your tasks further, tap **Menu > Filter > Active Tasks** or **Completed Tasks**.

To send task information as a vCalendar

Tap **Menu > Send as vCalendar** to send a vCalendar containing task details as a file attachment in an MMS message. For more information about sending MMS messages, see “MMS Messages” in Chapter 7.

6.5 Notes

Notes helps you to quickly capture thoughts, questions, reminders, to-do lists, and meeting notes. You can create handwritten and typed notes, record voice notes, convert handwritten notes to text for easy reading, and send notes to others.

Enter information in Notes

There are several ways to enter information in a note. You can enter typed text by using the on-screen keyboard or handwriting recognition software. You can use the stylus to write or draw directly on the screen.

To set the default input mode for Notes

If you frequently add drawings to your notes, you may find it helpful to set **Writing** as the default input mode. If you prefer typed text, select **Typing**.

1. Tap **Start > Programs > Notes**.
2. In the note list, tap **Menu > Options**.
3. In the **Default mode** box, tap one of the following:
 - **Writing** if you want to draw or enter handwritten text in a note.
 - **Typing** if you want to create a typed note.
4. Tap **OK**.

To create a note

1. Tap **Start > Programs > Notes**. In the note list, tap **New**.
2. Tap the **Input Selector** arrow next to the **Input Method** icon on the menu bar, tap the input method you want, and enter your text.
3. If the **Input Selector** arrow is not displayed, tap the **Input Method** icon.
4. When finished, tap **OK** to return to the note list.

- Notes**
- To select handwritten text, tap and hold next to the writing. As soon as dots appear, and before they form a complete circle, quickly drag across the writing.
 - If a letter crosses three ruled lines, it is treated as a drawing rather than text.

To draw in a note

1. Tap **Start > Programs > Notes**.
2. In the note list, tap **New**.
3. To draw on the screen, use the stylus like a pen.



Drawing on the screen

4. A selection box appears around your drawing.
5. When finished, tap **OK** to return to the note list.

Note To select a drawing (for example, to copy or delete it), tap and hold the drawing briefly. When you lift the stylus, the drawing is selected.

Record a voice note

You can create a stand-alone recording (voice note) or you can add a recording to a note.

To create a voice note

1. Tap **Start > Programs > Notes**.
2. Do one of the following:
 - To create a stand-alone recording, record from the note list.
 - To add a recording to a note, create or open a note.
3. If you do not see the Recording toolbar, tap **Menu > View Recording Toolbar**.
4. Tap the **Record** icon () to begin recording.
5. Hold your device's microphone near your mouth or other source of sound.

6. Tap the **Stop** icon () when finished recording.
7. If you are adding a recording to a note, tap **OK** to return to the note list when finished.
8. If you are recording in an open note, an icon will appear in the note.
9. If you are creating a stand-alone recording, the recording will appear in the note list.

Tip To quickly create a recording, press and hold the VOICE COMMAND button, then you can begin to record after a beep sound. Release the button when you are finished.

To change recording formats

1. Tap **Start > Settings > Personal tab > Input**.
2. Tap the **Options** tab, and select the desired format you want in the **Voice recording format** list.
3. Tap **OK**.

Note You can also change recording formats from within Notes. In the note list, tap **Menu > Options > Global Input Options** link (at the bottom of the page), then tap the **Options** tab.

6.6 Voice Recorder

Voice Recorder lets you record your voice and then quickly send it via MMS or e-mail, beam it or set the recorded voice as your ringtone. Voice Recorder saves the audio file in the AMR-NB format.



To record your voice

1. On the Today screen, tap **Start > Programs > Voice Recorder**.
2. Hold the device's microphone near your mouth.
3. Tap **Record** or  to start recording a voice clip. You can tap **Pause** to temporarily stop recording. When you want to continue recording, tap **Resume**.
4. Tap **Stop** to stop recording.

All recordings are saved in the **My Voices** folder by default. You can choose another folder to save voice recordings by tapping ▼ beside the folder name on the top-left of the screen and then in the menu, choose the folder where to save future recordings.

To play back a voice recording

1. On the Voice Recorder screen, select the voice recording you want to play back.
2. Tap . You can also double-tap the voice recording to play it back.

- Notes**
- Tap  to increase the volume; Tap  to decrease the volume.
 - Tap  to toggle between muting and unmuting the volume.

To send the voice recording via MMS

1. On the Voice Recorder screen, select the voice recording you want to send via MMS.
2. Tap **Menu > Send via MMS**. This automatically opens the MMS program with the voice recording automatically inserted as the audio file for the MMS message.

See “MMS Messages” in Chapter 7 to learn how to compose and send MMS messages.

To send the voice recording via e-mail

1. On the Voice Recorder screen, select the voice recording you want to send via e-mail.
2. Tap **Menu > Send > Outlook E-mail**. This automatically opens the Outlook E-mail with the voice recording automatically inserted as an attachment for the e-mail.

See “Using E-mail” in Chapter 7 to learn how to compose and send e-mails.

To beam the voice recording

1. On the Voice Recorder screen, select the voice recording(s) you want to beam.
2. Tap **Menu > Beam File**.
3. Tap the device you want to send the voice recording(s) to.
4. On the other device, accept the file transfer to receive the file.

To set the voice recording as a ring tone

1. On the Voice Recorder screen, select the voice recording you want to set as your device's ring tone.
2. Tap **Menu > Set as Ringtone**.

To rename or move a recording

1. On the Voice Recorder screen, select the voice recording you want to rename or move to another location.
2. Tap **Menu > Rename/Move**.
3. Enter the new **Name** for the voice recording.
4. To move the voice recording, select the new destination **Folder** and **Location**.
5. Tap **OK**.

Tip If multiple voice recordings are selected, you can only move the files but not rename them.

Chapter 7

Exchanging Messages

7.1 Messaging

7.2 Text Messages

7.3 MMS Messages

7.4 Setting Up E-mail Accounts

7.5 Using E-mail

7.1 Messaging

Messaging is where all of your e-mail accounts and your text message account are located. You can send and receive Outlook e-mail, Internet e-mail through an Internet service provider (ISP), as well as SMS (Short Messaging Service) text messages using your mobile phone network. You can also access e-mail from work using a VPN connection.

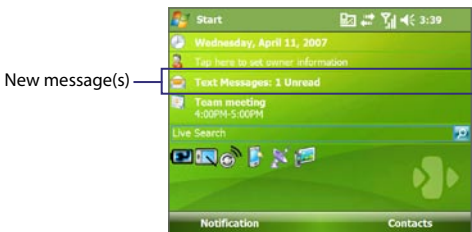

To select a messaging account

Do one of the following:

- Tap **Start > Messaging**. The Account Picker screen then appears where you can select an account.

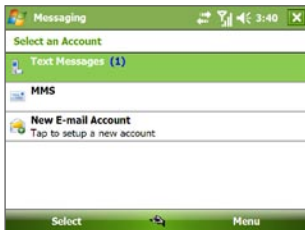

Account Picker screen

- While you are in a message list of a certain account, for example Text Messages, tap **Menu > Go To** to switch to other types of messaging accounts.

To configure message account settings

- Tap **Menu > Options** on the Account Picker screen; or
- Tap **Menu > Tools > Options** while you're in a message list.

7.2 Text Messages

Send short text messages up to 160 characters long to other mobile phones. For quicker and easier typing, use the QWERTY keyboard to enter your message.

Send text messages

To compose and send a text message

1. Tap **Start > Messaging**.
2. On the Account Picker screen, tap **Text Messages**.
3. Tap **New**.
4. Enter the mobile phone number of one or more recipients, separating them with a semicolon. To access mobile phone numbers from Contacts, tap **To**.
5. Enter your message.
 - To quickly add common messages, tap **Menu > My Text** and tap a desired message.
 - To check the spelling, tap **Menu > Spell Check**.
6. Tap **Send**.

Note If you want to know when a text message is received, before sending the message that you are composing, tap **Menu > Message Options** then select the **Request message delivery notification** check box. To always receive a delivery notification, tap **Menu > Tools > Options** in the text message list, tap **Text Messages**, then select the same check box.

Receive text messages

Text messages are automatically received when the phone function is turned on. When the phone is turned off, text messages are held by your wireless service provider until the next time the phone is turned on.

Copy text messages from and to the SIM card

1. On the Account Picker screen, tap **Text Messages**.
2. In the message list, select the text message you want to copy.
3. Do one of the following:
 - To copy a text message to the SIM card, tap **Menu > Copy to SIM**.
 - To copy a text message from the SIM card to your device, tap **Menu > Copy to Phone**.

Note Text messages stored on your SIM card are automatically displayed in the Inbox folder. Copying them to your device results in duplicate messages in the Inbox folder when your SIM card is in use.

7.3 MMS Messages

Creating and sharing multimedia messages (**MMS**) with your friends and family are easy with your device. You can attach pictures or video, and an audio clip in an MMS. You can even use the device camera to capture photos and video clips while composing a new MMS message, and send them along with your message.

- Notes**
- Please note that MMS is a charged service. In order to use MMS successfully, this has to be provisioned on your mobile account. Please contact the wireless service provider to have this provisioned as part of your calling plan.
 - Please ensure the size of the MMS is within the limits of the wireless service provider if sending to another mobile phone user or sending to an e-mail address.

To access MMS

1. Tap **Start > Messaging**.
2. On the Account Picker screen, tap **MMS**.

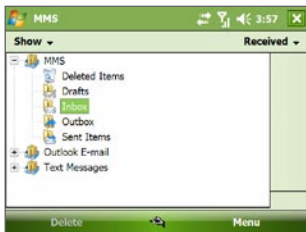

MMS message folders

Change MMS settings

When you send an MMS message, an SMS notification message will first be sent to the recipient, while your MMS message will be temporarily stored on an MMS server of your wireless service provider. When others send you an MMS message, similarly, the MMS message will be stored on the MMS server until you retrieve it. Hence, your device must be configured with the location of the MMS server for you to be able to send and receive MMS messages on your device.

When you purchase your device, it is already preset with your wireless service provider's MMS server settings. If you accidentally lost the preset settings or you changed to another wireless service provider, follow the steps below to configure MMS settings.

To configure MMS settings

1. Tap **Start > Messaging**.
2. Tap **Menu > Tools > Options**.
3. Tap **MMS** in the accounts list to configure settings. The MMS Configuration screen appears.
4. In the **Preferences** tab, select or clear the provided check boxes according to your needs. You can choose to keep track of your MMS messages, retrieve messages immediately, accept or reject messages, and request a delivery or read receipt. You can also specify a resolution for images you send and message delivery attempts.
5. Tap the **Servers** tab and check if your device is preset with MMS server settings.

If there are no preset settings, tap **New** and enter the following information, which you can get from your wireless service provider:



- **Server name.** A descriptive name, such as your wireless service provider name.
- **Gateway.** Location of the MMS server, which is usually in the form of an IP address.
- **Port number.** HTTP port number used for connecting to the MMS server and for file transfer.
- **Server address.** URL address of the MMS server.
- **Connect via.** Select the connection that your device uses for MMS.
- **Sending size limitation.** Select the maximum MMS message size allowed by your wireless service provider.
- **WAP version.** Select either **WAP 1.2** or **WAP 2.0**, depending on which one is being used by your wireless service provider.

6. Tap **OK**.

The MMS server settings will then be added as an entry on the MMS Configuration screen.

- Notes**
- If your device already has preset MMS settings, it is recommended that you do not change these settings. If you change the preset settings, your device may not be able to send and receive MMS messages.
 - If you add several MMS service providers to the MMS Configuration screen, you can choose one as your default MMS provider. Select the MMS provider's name in the list then tap **Set As Default**.

Create and send MMS messages

After configuring the required settings, you can start to compose and send MMS messages.

To compose an MMS message





You can compose MMS messages in a combination of various slides, where each slide can consist of a photo, audio or video clip, and/or text.

1. On the MMS screen, tap **New**.
2. When you see the Choose a MMS screen, tap a preset template, or tap **Custom** to open a blank MMS message.

Note If you prefer to always use a blank MMS message, select the **Always choose custom** check box.



3. In **To**, enter the recipient's phone number or e-mail address directly, or tap **To**, **Cc**, or **Bcc** to choose a phone number or an e-mail address from Contacts.
4. Enter a subject for your message.
5. Tap the **Insert** icon () to select and insert a photo or video clip.

When selecting a photo or video clip, you can:

- Tap  to view it first, then tap **Select** to use the selected photo or video clip and insert it into the MMS message you are composing.
 - Tap  to take a photo and insert it into the MMS message.
 - Tap  to record an MMS video clip and insert it into the MMS message.
 - Tap the **Exit** icon to quit selection and return to the MMS message.
6. Enter text and insert audio clips by tapping the respective areas. See “To add text to an MMS message” and “To add an audio clip to an MMS message” for details.
 7. To add more slides, tap  or tap **Menu > Slides > Insert Slide**. Repeat steps 5 and 6 to insert a photo/video, text, and audio into each slide that you added.

While on a slide, you can:

- Tap  to preview the slide.

- Tap  to go to the previous slide.
 - Tap  to go to the next slide.
8. While composing an MMS message, you can also do the following:
- Tap **Menu > Options > Background** to choose a background color from the list.
 - Tap **Menu > Options > Text Layout**, then choose whether to place the text above, below, to the left or right of the photo/video.
 - Tap **Menu > Options > Send Options** to specify the sending time, validity, priority, class, and other settings for a message.
 - Tap **Menu > Attachment** to include a contacts card, calendar appointment, or any file as an attachment.
9. Tap **Send** to send the MMS message.

Notes You can also send an MMS message directly from the Pictures & Videos or Camera program. Do one of the following:

- In Pictures & Videos, select a picture from My Pictures, and tap **Menu > Send**. In **Select an account**, tap **MMS**.
- Capture a photo or an MMS video clip using the camera, and tap the **Send** icon. In the Send File dialog box, tap **Send via MMS**.



To create an MMS message from a template

- While on an MMS message, tap **Menu > Template > New from Template** to compose a message using a predefined template.

Note To save a message as a template, open the message and tap **Menu > Template > Save as Template**.

To add text to an MMS message

When entering text into an MMS message, you can do the following:

- Tap inside the text box and enter your own text.
- Choose from common words or phrases. Tap  to add a text string from the My Text list.
- Tap  to add an emoticon.
- You can easily include a Web page link. Tap  then select a Web page address from the Internet Favorites list on your device.

Tip To edit or delete a phrase on the My Text list, tap and hold a string, then tap **Edit** or **Delete** from the shortcut menu. To create and add a new phrase to the list, tap **New**.





To add an audio clip to an MMS message

You can add audio clips to your MMS message. However, you can add only one audio clip per slide.

1. Tap **Insert audio**.



By default, My Documents will be shown. Tap My Music or another folder that contains audio files. When navigating folders, tap the Down arrow (▼) to return to the upper folder.

2. Select an audio file. When selected, you can:

- Tap  to play the audio clip.
- Tap  to pause, or tap  to stop playback.
- Tap **Select** to insert it into your MMS message.
- Tap the **Exit** icon to quit selection and return to your MMS message.
- To record a new audio clip and add it to your MMS message, tap . The Record pop-up window then opens. Tap **Record** to start recording, and **Stop** to end the recording. Tap **Play** to listen to the recorded audio clip, then tap **Done**. The new audio clip is automatically inserted into your MMS message.

View, and reply to MMS messages

To view an MMS message

- Use the playback controls , , and .
- Tap **Objects** to see a list of files included in the message. On the Message Objects screen, you can do the following:
 - To save a file, select it, and tap **Menu > Save**.
 - To save the contents of a text file to the My Text list, tap **Menu > Save into "My Text"**.
 - To associate a photo to one of your contacts, tap **Menu > Assign to Contact**.

To reply to an MMS message

- Tap **Menu > Reply** to reply to the sender of the message, or tap **Menu > Reply All** to reply to all persons listed in To, Cc, and Bcc of the message.

7.4 Setting Up E-mail Accounts

Types of E-mail Accounts

Before you can send and receive e-mail, you need to set up your e-mail account on your device. You can set up the following types of e-mail accounts on your device:

- Outlook e-mail that you synchronize with your PC or your company's Exchange Server.
- E-mail account that you have from an Internet Service Provider (ISP).
- Web-based e-mail accounts such as Yahoo!® Mail, AOL®, etc.
- Work account that you access using a VPN connection.

E-mail Setup Wizard

Windows Mobile's E-mail Setup Wizard lets you easily set up your personal and work e-mail accounts. You can add an e-mail account from an Internet Service Provider (ISP) or other e-mail provider as well as Web-based accounts.

Note For more information about setting up your company Outlook e-mail account, see Chapter 8.

To set up a POP3 or IMAP4 e-mail account

1. Tap **Start > Messaging > New E-mail Account**.
2. Enter your e-mail address, and select the **Try to get e-mail settings automatically from the Internet** check box. By selecting the option, the device attempts to download e-mail server settings so that you do not need to enter them manually. Tap **Next**.
3. After Auto Setup finishes, tap **Next**.

Note If Auto Setup is unsuccessful, select Internet e-mail from the Your e-mail provider list on the next screen. You will also be asked to enter e-mail server settings during the setup process. See "To specify e-mail server settings" for details.

4. Enter your name. You can also edit the **Account display name** field to specify the name of your ISP or e-mail provider. Tap **Next**.
5. Enter your login name if it does not show automatically in the User name field. Also enter your password, and select the **Save password** check box. Tap **Next**.
6. At this point, e-mail setup is complete. In the **Automatic Send/Receive** list, choose how frequent you want e-mail messages to be automatically sent and downloaded on your device.

Note Tap **Review all download settings** to select download options, set the e-mail format as HTML or plain text, and more. For more information, see "To customize download and format settings."

7. Tap **Finish**.

To specify e-mail server settings

If Auto Setup is unsuccessful, contact your ISP or e-mail provider for the **Incoming mail server** and **Outgoing mail server** settings so you can enter them on your device.

Other options that you can select include the following:

- Select the **Outgoing server requires authentication** check box, if required by your provider.
- If the outgoing e-mail server requires a different user name and password for sending e-mail, clear the **Use the same user name and password for sending e-mail** check box. You will be prompted to enter this information.
- Tap **Advanced Server Settings**, then select the **Require SSL** check boxes if your e-mail provider uses an SSL connection for more secured e-mail.
From the **Network connection** list, select the data connection that you use for connecting to the Internet.

To customize download and format settings

Before you tap Finish when setting up your POP3 or IMAP4 e-mail account, you can tap **Review all download settings** to choose download options, message format, and other settings.

Options	Description
Automatic Send/Receive	You can select a time interval for connecting to the Internet automatically to send and receive messages.
Download messages	Set the number of days of messages that you want to be downloaded to your device.
Send/receive when I click Send	By default, messages are immediately delivered when you tap Send. If you prefer to save outgoing messages to the Outbox folder first, clear the check box. (In this case, you will need to manually send messages by tapping Menu > Send/Receive).
Use automatic send/receive schedule when roaming	This allows your device to data roam when there is a set time interval for connecting to the Internet automatically. Since this may result in higher connection costs, you may want to leave the check box cleared.
When deleting messages	Choose whether to delete messages from the mail server when you delete them on your device.
Message format	Select HTML or Plain Text.
Message download limit	Select the e-mail download size. If you have large volumes of e-mail, use a lower size or select to download headers only.

7.5 Using E-mail

After setting up e-mail accounts on your device, you can start sending and receiving e-mail messages.

Create and send e-mail messages

To compose and send an e-mail message

1. Tap **Start > Messaging**.
2. On the Account Picker screen, select an e-mail account.
3. Tap **Menu > New**.
4. Enter the e-mail address of one or more recipients, separating them with a semicolon. To access e-mail addresses stored in Contacts, tap **To**.
5. Enter your message. To quickly add common messages, tap **Menu > My Text** and tap a desired message.
6. To check the spelling, tap **Menu > Spell Check**.
7. Tap **Send**.

- Tips**
- To enter symbols, tap **Shift** using the on-screen keyboard then tap a symbol, or use the Symbol Pad. For more information about entering text and symbols, see Chapter 2.
 - To set the priority, tap **Menu > Message Options**.
 - If you are working offline, e-mail messages are moved to the Outbox folder and will be sent the next time you connect.

To add an attachment to an e-mail message

1. In the message that you are composing, tap **Menu > Insert** and tap the item you want to attach: **Picture**, **Voice Note**, or **File**.
2. Select the file you want to attach, or record a voice note.

View and reply to e-mail messages

To read an incoming e-mail message

By default, only the first few kilobytes of a message are shown when you open and read an incoming message. To read the whole message, do one of the following:

- Scroll down to the end of the message and tap **Get the rest of this message**; or
- Tap **Menu > Download Message**.

The message will be downloaded the next time you tap **Menu > Send/Receive** to send and receive e-mail.

- Notes**
- If your company is running Microsoft Exchange Server 2007, the message downloads immediately, without waiting until the next time you synchronize. For more information about working with company e-mails, see Chapter 8.
 - The size column in the message list displays the local size and server size of a message. Even when an entire message has been downloaded, these numbers may differ because the size of a message can vary between the server and the device.

To download an attachment

An attachment appears below the subject of the message. Tapping the attachment opens the attachment if it has been fully downloaded or marks it for download the next time you send and receive e-mail.

- Notes**
- If there are multiple attachments in the message, all attachments are downloaded.
 - For information about setting your device to automatically download file attachments, see "Customize e-mail settings."
 - If your company is running Microsoft Exchange Server 2007, the attachment downloads immediately, without waiting until the next time you synchronize. For more information about working with company e-mails, see Chapter 8.

To reply to or forward a message

1. Open the message and tap **Reply**, or **Menu > Reply All**, or **Menu > Forward**.
2. Enter your response. To quickly add common messages, tap **Menu > My Text** and tap a desired message.
3. To check the spelling, tap **Menu > Spell Check**.
4. Tap **Send**.

- Tips**
- To see more header information, scroll up.
 - To always include the original message, from the list view, tap **Menu > Tools > Options > Message** tab, and select the When replying to e-mail, include body check box.
 - In the Outlook E-mail account, you will send less data if you do not edit the original message. This may reduce data transfer costs based on your rate plan.

To view and reply to HTML e-mails

You can receive, view and reply to HTML e-mails from any type of e-mail account. The HTML format is retained, without layout shifting or resizing.

Note HTML e-mail support in Outlook Mobile is available only if your company is using Microsoft Exchange Server 2007.

1. Set the message format to HTML. To find out how to set the message format, see “Customize e-mail settings.”
2. Tap **Start > Messaging** then select an e-mail account.
3. Open an HTML e-mail that you received.
4. Tap the **Tap to scroll right** option to be able to scroll sideways and get a complete horizontal view of the message.
5. Tap **Get the rest of this message** that’s shown at the bottom of the message to download and view the whole message.
6. If the e-mail does not download immediately, tap **Menu > Send/Receive**.
7. If images do not immediately appear on the message, tap **Internet pictures blocked** then tap **Download Internet pictures**.
8. Tap **Menu** and choose whether to reply to the sender(s) or forward the message.
9. Enter your response then tap Send.

Tip E-mail can contain hyperlinks to Web pages.

Download e-mail messages

The manner in which you download messages depends on the type of account you have.

To send and receive e-mail for an Outlook account

1. Tap **Start > Programs > ActiveSync**.
2. Connect your device to your PC using the USB cable or Bluetooth. Otherwise, connect wirelessly if you are synchronizing Outlook e-mail with the Exchange Server. For more information, see Chapter 8.
3. Synchronization automatically begins, and your device sends and receives Outlook e-mail.

Tip You can also manually synchronize anytime by tapping **Sync** in **ActiveSync or Menu > Send/Receive** in Outlook Mobile.

To send and receive e-mail for a POP3/IMAP4 account

If you have an e-mail account with an ISP or a work account that you access using a VPN server connection, you send and receive messages through a remote e-mail server. Before sending and downloading messages, you first need to connect to the Internet or your corporate network.

1. Tap **Start > Messaging** then select your POP3 or IMAP4 e-mail account.
2. Tap **Menu > Send/Receive**. The messages on your device and e-mail server are synchronized: new messages are downloaded to the device Inbox folder, messages in the device Outbox folder are sent, and messages that have been deleted from the server are removed from the device Inbox folder.

Customize e-mail settings

To change the download size and format for Outlook e-mail

1. Disconnect your device from the computer.
2. Tap **Start > Programs > ActiveSync**.
3. Tap **Menu > Options**, select **E-mail**, then tap **Settings**.
4. On the E-mail Sync Options screen:
 - Under **Download size limit**, select the desired email size.
 - Under **Message format**, select HTML or Plain text.
5. Close ActiveSync and reconnect your device to the computer.

To change the download size and format for POP3/IMAP4 e-mail

1. Tap **Menu > Options** on the Account Picker screen, or tap **Menu > Tools > Options** while you're in a message list.
2. Tap your e-mail account.
3. Keep tapping **Next** until you see the **Message download limit** option.
4. Select the desired email size.
5. Under **Message format**, select HTML or Plain text.
6. Tap **Finish**.

To exclude your e-mail address when replying to all

When you reply to all the recipients of an Outlook e-mail, your own e-mail address will also be added to the recipient list. Customize ActiveSync so that your e-mail address will be excluded from the recipient list.

1. Tap **Start > Programs > ActiveSync**.
2. Tap **Menu > Options**, select **E-mail**, then tap **Settings**.
3. Tap **Advanced**.
4. In the **My e-mail addresses** text box, enter your e-mail address.
5. Tap **OK**.

To automatically receive attachments on Outlook e-mails

1. Tap **Start > Programs > ActiveSync**.
2. Tap **Menu > Options**, select **E-mail**, then tap **Settings**.
3. Select **Include file attachments**.

To automatically receive attachments on IMAP4 e-mails

1. Tap **Start > Messaging**.
2. Tap **Menu > Options**.
3. Tap the name of your IMAP4 account.
4. Tap **Next** until you reach **Server information**, then tap **Options**.
5. Tap **Next** twice, then select a download size from the **Download attachments smaller than** list box.

To store attachments on a storage card

1. Tap **Start > Messaging** then select an e-mail account.
2. Tap **Menu > Tools > Options > Storage** tab.
3. Select the **Store attachments on storage card** check box.

Chapter 8

Working With Company E-mails and Meeting Appointments

**8.1 Synchronizing Your Device with
the Exchange Server**

8.2 Working With Company E-mails

8.3 Managing Meeting Requests

8.4 Finding Contacts in the Company Directory

8.5 E-mail Security



8.1 Synchronizing Your Device with the Exchange Server

To keep up to date with your company e-mails and meeting schedules while you're out of the office, you can connect your device to the Internet wirelessly and synchronize this information with your company's Exchange Server. You can also access your company address book anytime. Your company must have a mail server that is running Microsoft Exchange Server with Exchange ActiveSync.

Before you can start to synchronize with or access information from the Exchange Server, you need to set up an Exchange Server connection on your device. You need to get the following information from your network administrator and enter them on your device: Exchange Server name (must be the Outlook Web Access server name), domain name, and the user name and password that you use at work.

You can set up the Exchange Server connection either from your device or your PC.

Set up an Exchange Server connection from your device

If you have not synchronized your device with your PC, follow these steps to set up an Exchange Server connection.

1. Tap **Start > Messaging > New E-mail Account**.
2. Enter your e-mail address. Clear the **Try to get e-mail settings automatically from the Internet** check box, then tap **Next**.
3. Select **Exchange server** in the **Your e-mail provider** list, then tap **Next**.
4. Tap **Next** again.
5. In **Server address**, enter the Exchange Server name, and tap **Next**.
6. Enter your user name, password, and domain, and tap **Next**.
Note To change the rules for resolving synchronization conflicts, tap **Advanced**.
7. Select the check boxes for the types of information items that you want to synchronize with the Exchange Server.

8. To change synchronization settings of an information type, for example, E-mail, select the type of information, and tap **Settings**.

9. Tap **Finish**.

Note If you synchronized e-mails with your PC before, open ActiveSync on your device and tap **Menu > Add Server Source** to set up an Exchange Server connection. When you're prompted to select information types for synchronization, you need to clear the **E-mail** check box under the Windows PC item first before you can select the **E-mail** check box under Exchange Server.

Tip To change Exchange Server settings, open ActiveSync then tap **Menu > Configure Server**.

Set up an Exchange Server connection from your PC

On a Windows Vista PC

1. Set up synchronization between your PC and device. See Chapter 5 for details.
2. Click **Start > All Programs > Windows Mobile Device Center** on your PC.
3. On Windows Mobile Device Center's Home screen, mouse over **Mobile Device Settings**, click **>>more**, then click **Sync wirelessly with Exchange Server**.



4. Enter your company's Exchange server address, your username, password, and domain.
5. Click **Set Up**.

Sync wirelessly with Exchange Server

Set up sync over a cellular or wireless connection

You can set up your device to receive E-mail, Contacts, Calendar and Task items over a cellular or wireless network when you are not connected to the PC.

Server address:

If you use Outlook Web Access, this is the same as your OWA server address.

This server requires an encrypted (SSL) connection

User name:

Password:

Domain:

Save password
(Required to sync as new items arrive)

[Learn more about synchronizing directly with Exchange Server](#)

6. On Windows Mobile Device Center's Home screen, click **Change content sync settings**.
7. Select the check box of items you want to synchronize with the Exchange Server. Tap **Sync Settings** to choose synchronization settings for the selected items.



8. Tap **Save**.

On a Windows XP PC

1. Install Microsoft ActiveSync on your PC if you have not yet done so. See “Install ActiveSync” in Chapter 5 for details.
2. Connect your device to the PC.
3. If you have not set up synchronization with your PC before, follow the steps in “Set up synchronization in ActiveSync” in Chapter 5 and make sure to select the **Synchronize directly with a server running Microsoft Exchange** option in the Synchronization Setup Wizard:
4. If you have synchronized your device with your PC before, do the following steps to set up synchronization with the Exchange Server:
 - a. Right-click the **ActiveSync** icon () at the bottom right side of your PC, then click **Open Microsoft ActiveSync**.
 - b. In ActiveSync on your PC, click **Tools > Add Server Source** then enter your company’s Exchange Server address, your username, password, and domain, then click **OK**.

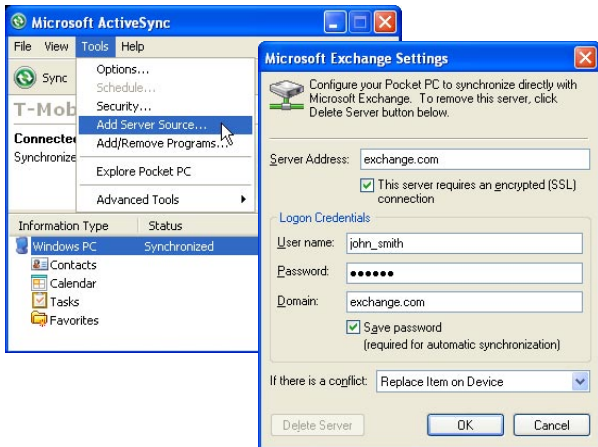

- c. Choose the items to be synchronized and other settings in the **Options**, **Schedule** and **Security** tabs, then click **OK**.

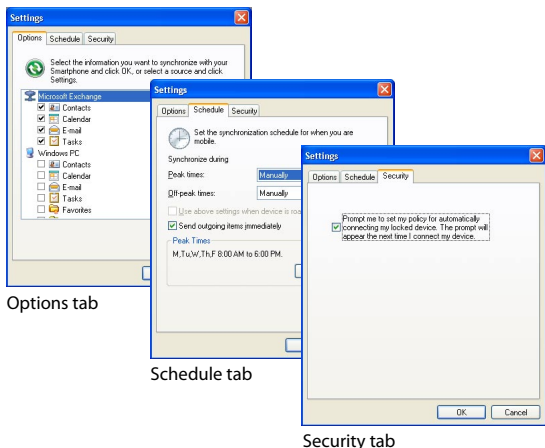

Start synchronization

Before you start synchronizing with the Exchange Server, make sure your device has been set up with a data connection to the Internet so that you can synchronize wirelessly. For more information about connections, see Chapter 9.

After you finish setting up an Exchange Server connection, your device automatically starts synchronization.

You can manually start synchronization anytime by tapping **Sync** in ActiveSync.

- Notes**
- You need a data plan from your wireless service provider to be able to synchronize with the Exchange Server.
 - If you connect your device to your office computer via a USB or Bluetooth connection, you can use this connection to the PC to “pass through” to the network and download Outlook e-mails and other information to your device.

8.2 Working With Company E-mails

Your device gives you instant access to your company e-mails and lets you manage your messages easier. Direct Push, Fetch Mail, Remote e-mail search, and e-mail flags are just some of the tools you can use to manage your e-mails.

Note Some messaging features depend on the Microsoft Exchange Server version used in your company. Please check with your network administrator for the availability of these features.



Automatic synchronization through Direct Push

Direct Push technology (push e-mail feature) enables you to receive new e-mails on your device as soon as they arrive in your Inbox on the Exchange Server. With this feature, items such as contacts, calendar and tasks are also immediately updated onto your device when these items have been changed or new entries have been added on the Exchange Server. To make Direct Push work, you need to have a GPRS/EDGE connection on your device.

You need to perform a full synchronization between your device and the Exchange Server first before Direct Push can be enabled.

Requirement The Direct Push feature works for your device only if your company is using **Microsoft Exchange Server 2003 Service Pack 2 (SP2) with Exchange ActiveSync or higher version** or an equivalent push e-mail solution.

To enable Direct Push via Comm Manager

1. On the Today screen, tap the **Comm Manager** icon ().
2. On the Comm Manager screen, tap the **DirectPush** button. The button  will turn to , which indicates that you will receive e-mails as they arrive.

When the button is in the  state, you need to manually retrieve your e-mails.

To enable Direct Push via ActiveSync

1. In ActiveSync on your device, tap **Menu > Schedule**.
2. Select **As items arrive** in the **Peak times** and **Off-peak times** boxes.

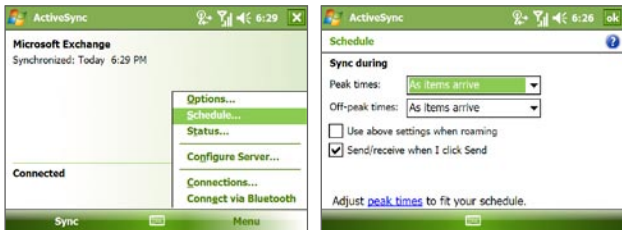

Note When both the GPRS/EDGE and Wi-Fi connections are turned on at the same time, the Direct Push feature will always opt for GPRS/EDGE, for which you could be charged per your network operator's service plan.

Scheduled synchronization

If you do not want to use Direct Push, you can set a regular schedule for synchronizing Outlook e-mail and information. Set how often to synchronize during **Peak times** (which usually refer to your working hours) when e-mail volume is high, as well as **Off-peak times** when e-mail volume is low.

1. In ActiveSync on your device, tap **Menu > Schedule**.
2. Select a shorter time interval in the **Peak times** box for you to be able to receive e-mails more frequently.
3. Select a longer interval in the **Off-peak times** box.

Tip To set the days and hours that make up your peak and off-peak times, tap **Adjust peak times to fit your schedule**.

Instant download through Fetch Mail

The **Fetch Mail** feature downloads an entire e-mail immediately without the need for you to perform a full Send/Receive action. This limits the download to just the e-mail message that you want and helps save data cost.

Requirement Fetch Mail works for your device only if your company is using **Microsoft Exchange Server 2007 or higher**.

1. Tap **Start > Messaging > Outlook E-mail**.
2. Tap an e-mail message to open it.
3. By default, only the first few kilobytes of the message is shown. To download the whole e-mail, scroll to the bottom of the message then tap **Get the rest of this message**.
4. A “Downloading message” status appears. Wait for the remainder of the message body to be downloaded.

Tip For information about changing e-mail sync options such as the initial download size limit for e-mail, see “Customize e-mail settings” in Chapter 7.

Search for e-mails on the Exchange Server

You can access messages that are not available on your device by searching your Microsoft Exchange Server mailbox. The search results will be downloaded and displayed in a Search Results folder.

Requirement Your company must be using **Microsoft Exchange Server 2007 or higher**.

1. Tap **Start > Messaging > Outlook E-mail**.
2. Tap **Menu > Tools > Search Server**.
3. In the **Look for** text box, enter the search keyword.
4. Choose the date range of messages to search from.
5. From the **Look in** list, choose whether to search from your inbox or outbox only or to search all folders.
6. Tap **Search**.



Flag your messages

Flags serve as a reminder to yourself to follow-up on important issues or requests that are indicated in the messages. Flagging messages, which has been a useful feature on desktop Outlook E-mail, can also be done in Outlook Mobile on your device. You can flag received messages on your device.

Requirement Flags are enabled only if e-mails are synchronized with **Microsoft Exchange Server 2007 or higher**. Flags are disabled or hidden if e-mails are synchronized with earlier versions of Microsoft Exchange Server.

To flag or unflag a message

1. Tap **Start > Messaging > Outlook E-mail**.
2. Select a message, or open a message.
3. Tap **Menu > Follow Up** and select one of the following options:



- **Set Flag** Mark the message with a red flag to indicate that it needs follow up.
- **Complete Flag** Mark the message with a check mark to indicate that the issue or request in the e-mail is already completed.
- **Clear Flag** Remove the flag to unmark the message.

Note E-mail message reminders are displayed on your device if the messages are flagged with reminders and synchronized from the Exchange Server.

Out-of-office auto-reply

Outlook Mobile allows you to retrieve and change your out-of-office status. Just like desktop Outlook E-mail, Outlook Mobile automatically sends an auto-reply message when you're not available.

To send out-of-office auto-reply messages

1. Tap **Start > Messaging > Outlook E-mail**.
2. Tap **Menu > Tools > Out of Office**.
3. From the **I am currently** list, select **Out of the Office**.
4. Enter your auto-reply message then tap **Done**.



View a document linked to an e-mail message

When you receive an e-mail that contains a link to a document such as a PDF or Microsoft® Office document located on SharePoint or an internal file server, you can view the document on your device.

Requirement You can view the document only if you have a Microsoft Outlook account that synchronizes with Microsoft Exchange Server 2007 or later. Exchange Server must also be set up to allow access to SharePoint document libraries or internal file servers.

1. On the Today screen, tap **Start > Messaging**.
2. Select an e-mail account, then open a message with a link to a SharePoint document.
3. Tap the link to open and view the document.

8.3 Managing Meeting Requests

When you schedule and send meeting requests from your device, you can invite attendees to your meeting and check their status to know about their availability.

When you receive a meeting request, you can reply by accepting or declining the request. The meeting request also clearly indicates whether or not there are conflicting or adjacent meetings.

Note You can still accept meeting requests on your device if your company is using an earlier version of Microsoft Exchange Server, but some features will not be enabled. To use the features mentioned in this section, your company must be using **Microsoft Exchange Server 2007 or higher**.

To reply to a meeting request

1. When you receive a meeting request e-mail, a notification message will be displayed on your device. Tap **View** to open the e-mail.
2. Tap **Accept** to reply and accept the meeting request, or tap **Menu > Decline** if you cannot attend the meeting.

Tips

- Before responding, you can check your availability during the time of the requested meeting by tapping **View your calendar**.
- If the time of the meeting conflicts with your other appointments, a “Scheduling Conflict” status appears on top of the e-mail.

3. Choose whether or not to edit your response e-mail before sending then tap **OK**:

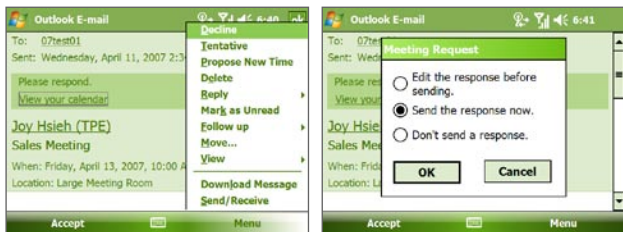

4. If you accepted the meeting request, it will automatically be added as an appointment in Calendar on your device.

To view the list of meeting participants

1. Tap **Start > Calendar**.
2. Tap a meeting request that you previously sent, then tap **Attendees**. The list of required and optional attendees will be listed.

- Notes**
- For information about creating a meeting request, see “To send a meeting request” in Chapter 6.
 - If you select a meeting that you have organized, the list shows who has accepted or declined the meeting.
 - To view an attendee’s contact information, tap the attendee’s name. If the attendee is included in your contacts list, you will see the contact information immediately. If the attendee is not in your contacts list, tap **Company Directory** to view the contact information.

8.4 Finding Contacts in the Company Directory

In addition to having contacts on your device, you can access contact information from your organization’s Company Directory. By having over-the-air access to the Company Directory, you can easily send e-mail messages and meeting requests to anyone in your company.

Requirement Access to the Company Directory is available only if your organization is running Microsoft Exchange Server 2003 SP2 or higher, and you have completed your first synchronization with the Exchange Server.

1. Synchronize with Exchange Server if you have never done so.
2. Do any of the following:
 - In Contacts, tap **Menu > Company Directory**.
 - In a new message, tap the **To** box. Tap **Menu > Add Recipient** then tap **Company Directory**.

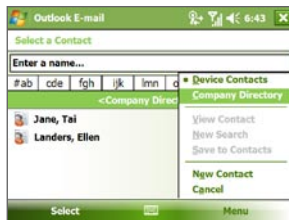

- In a new meeting request using Calendar, tap **Attendees** and then tap **Company Directory** at the top of the list.
3. Enter the part or full contact name and tap **Search**. In the search results list, tap a contact to select it.



- Notes**
- You can save a contact from the Company Directory to your device by selecting the contact then tapping **Menu > Save to Contacts**.
 - You can search on the following information as long as that information is included in the Company Directory: First name, Last name, E-mail name, Display name, E-mail address, or Office location.

8.5 E-mail Security

Windows Mobile® on your device protects your Outlook e-mails through Secure/Multipurpose Internet Mail Extension (S/MIME), which allows you to digitally sign and encrypt your messages.

Digitally signing a message applies your certificate with the authorization key to the message. This proves to the recipient that the message is from you and not from an imposter or a hacker, and that the message has not been altered.

Encryption protects the privacy of your message by converting it from plain, readable text into cipher (scrambled) text. Only the recipient who has the authorization key can decipher the message.

Requirement S/MIME encryption and digital signatures for Windows Mobile-based devices are available only with Exchange Server 2003 SP2 or a later version that supports S/MIME. If you are not using one of these products, or have not yet synchronized, these options are unavailable.

Note You can encrypt a message with or without a certificate. However, to read an encrypted message, you need a valid certificate to decrypt it.

To individually sign and encrypt a new message

1. Tap **Start > Messaging > Outlook E-mail**.
2. Tap **Menu > New** to create a new message.
3. Tap **Menu > Message Options**.
4. From the **Security** list, select whether to encrypt only, sign the message only, or do both.
5. Tap **OK**.

To verify the digital signature on a signed message you receive

1. Open the Outlook e-mail message that has been digitally signed.
2. At the top of the message, tap **View Signature Status**.



3. Tap **Menu > Check Certificate**.



To view the details of the certificate in the message, tap **Menu > View Certificate**.

Note There can be several reasons why a digital signature is not valid. For example, the sender's certificate may have expired, it may have been revoked by the certificate authority, or the server that verifies the certificate is unavailable. Contact the sender to report the problem.

To digitally sign and encrypt all messages

You can set up ActiveSync to digitally sign and encrypt all outgoing messages. You must obtain a valid certificate to sign and encrypt e-mail messages successfully.

1. Tap **Start > Programs > ActiveSync**.
2. Tap **Menu > Options**.
3. Select the **E-mail** information type, and tap **Settings**. On the E-mail Sync Options screen, tap **Advanced**.

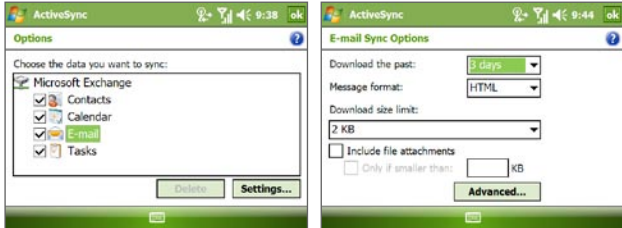

4. Do one or both of the following:
 - To sign all your outgoing e-mail messages so that recipients can be certain that the messages were sent by you and have not been altered in any way, select the **Sign all outgoing e-mail messages** check box.
 - To encrypt all your outgoing e-mail messages so that the contents of your messages are protected from being viewed by anyone other than the intended recipients, select the **Encrypt all outgoing e-mail messages** check box.
5. Tap **Choose Certificate** to select a certificate for signing or encrypting outgoing e-mail messages.

Set permissions on an e-mail message

Another way of protecting your e-mail messages is to send messages with restricted permissions using Information Rights Management (IRM).

Requirement This works only with a Microsoft Outlook e-mail account and if your company is using RMS Server SP1.

1. Tap **Start > Messaging > Outlook E-mail**.
2. Create a message, then tap **Menu > Message Options**.
3. In **Permissions**, do one of the following:
 - To allow anyone to read the message, select **Unrestricted access**.
 - To prevent the message from being forwarded, printed, or copied, select **Do not forward**.
4. Tap **OK**.

Tip An IRM-protected message received on your device can only be replied to or forwarded if the message permits it.

Chapter 9

Getting Connected

- 9.1 Using Comm Manager**
 - 9.2 Connecting to the Internet**
 - 9.3 Using VueFLO**
 - 9.4 Internet Explorer Mobile**
 - 9.5 Opera Browser**
 - 9.6 Using Bluetooth**
 - 9.7 Using Internet Sharing**
- 

9.1 Using Comm Manager

Comm Manager acts like a central switch that lets you enable or disable phone features as well as manage your data connections easily.

To open Comm Manager

- Tap the **Comm Manager** icon (📶) on the Today screen.

Simply tap the corresponding button to enable or disable a feature.

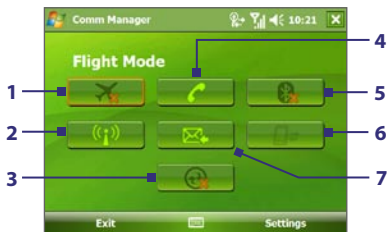

- 1 Tap to toggle between turning on or off Flight mode. Turning on Flight mode turns off the phone, Bluetooth and WLAN functions.
- 2 Tap to toggle between turning on or off Wi-Fi. Tap **Settings > Wireless LAN** to configure Wi-Fi on your device.
- 3 Tap to open ActiveSync so you can synchronize the device and computer. For more information about the configuration settings for ActiveSync, see Chapter 5.
- 4 Tap to toggle between enabling or disabling the phone. Tap **Settings > Phone** to set the ring tone and other phone settings. For more information about customizing phone settings, see Chapter 4.
- 5 Tap to toggle between turning on or off Bluetooth. Tap **Settings > Bluetooth** to configure Bluetooth on your device. See "Using Bluetooth" for details.
- 6 Tap to disconnect active data services (e.g. GPRS). You cannot reconnect data services in Comm Manager.
- 7 Tap to toggle between automatically receiving (as items arrive) or manually retrieving Outlook e-mails.

9.2 Connecting to the Internet

Ways of Connecting to the Internet

Your device's networking capabilities allow you to access the Internet or your corporate network at work through wireless and conventional connections. You can connect to the Internet through one of the following connections:

- Wi-Fi
- GPRS or EDGE
- Dial-up
- Work connections, such as Virtual Private Network (VPN) and proxy connections

Wi-Fi

Wi-Fi provides wireless Internet access over distances of up to 100 meters. To use Wi-Fi on your device, you need access to a wireless access point of your service provider. When you are in public places such as in a coffee shop or restaurant, you will need access to their public wireless access points (also referred to as “hotspots”).

Note The availability and range of your device's Wi-Fi signal depends on the number, infrastructure, and other objects through which the signal passes.

To connect to a wireless network

1. Open **Comm Manager**.
2. Tap the **WLAN** button to turn on/off the wireless function. The WLAN icon indicates the wireless status.



: Wi-Fi is turned on.



: Wi-Fi is turned off.

3. After Wi-Fi has been turned on, your device then scans for available wireless networks in your area. The network names of the detected wireless networks will be displayed on a pop-up message window. Tap the desired wireless LAN, then tap **OK**.

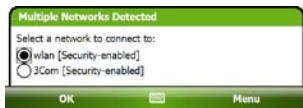

- On the next pop-up message window, tap **The Internet** if the wireless LAN connects your device to the Internet. Otherwise, tap **Work** if the wireless LAN connects your device to a private network.
- If the wireless LAN is secured by a network key, enter this key, then tap **Connect**.

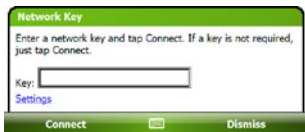

Next time you use your device to detect wireless networks, you will not see the pop-up message windows again, and you will not be prompted to enter the network key of the previously accessed wireless network (unless you perform a hard reset which will erase custom settings on your device).

Note Wi-Fi networks are self-discoverable, which means no additional steps are required for your device to connect to a Wi-Fi network. It may be necessary to provide a username and password for certain closed wireless networks, however.

To save battery power while connected to a wireless network

- Tap **Start > Settings > Connections** tab > **Wireless LAN** to open the Wireless LAN Settings screen.
- On the **Power Mode** tab of the Wireless LAN Settings screen, move the **Power Save Mode** slider to a position that optimizes performance with the least power consumption.





For example, move the slider to the left (Best Performance) to have the optimal WLAN performance; move to the right (Best Battery) to obtain the maximum battery usage.

Select **Auto turn off WLAN if not connected** then set a time to automatically turn off WLAN if it is not able to connect to a WLAN network after a set period of time.

To check the wireless LAN status

You can check the current wireless connection status from the following three screens of your device:

- **Title bar.** When you enable Wi-Fi on your device, the Wi-Fi ON icon () will appear on the title bar. After Wi-Fi is turned on, your device scans for available wireless networks and the wireless signal icon () appears on the title bar. The arrows in this icon will move back and forth while your device is scanning for a wireless LAN signal. Once your device successfully connects to a wireless LAN, the arrows stop moving.
- **Wireless LAN screen - Main tab.** Here, it shows the name of the wireless network that your device is currently connected to. The configuration and signal quality of the wireless network are also shown.
- **Configure Wireless Networks screen.** Tap **Start > Settings > Connections tab > Wi-Fi > Wireless** tab. This screen displays the wireless networks currently available.

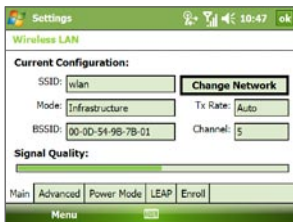

Wireless LAN: Main tab



Wi-Fi: Wirelss tab

- To connect to a wireless network in the list, tap and hold on the desired network, then tap **Connect**.
- Tap a wireless network in the list to view or change its connection settings.
- You can also add new wireless networks, if available, by tapping **Add New**.

GPRS/EDGE

GPRS is a data service that allows information to be sent and received across the wireless network. You can use GPRS to connect to the Internet or to send and receive MMS on your device. You will be billed per KB (Kilobyte) by your wireless service provider when you are sending or receiving information via GPRS.

To add a new GPRS/EDGE connection

If GPRS settings are not preset on your device, obtain the **Access point name** from your wireless service provider. Also, check with your wireless service provider if a user name and password are required.

1. Tap **Start > Settings > Connections** tab > **Connections**.
2. Under **Media Net**, tap **Add a new modem connection**.
3. On the Make New Connection screen, enter a name for the connection.
4. In the **Select a modem** list, select **Cellular Line (GPRS, 3G)**, then tap **Next**.

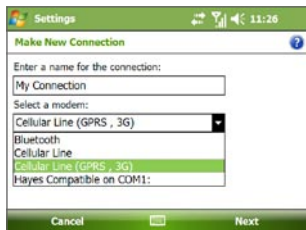

5. Enter the Access point name, then tap **Next**.



6. Enter the user name and password, only if required.

7. Tap **Finish**.

- Notes**
- To view help information for any screen, tap the help icon (?).
 - To modify your connection settings, tap **Manage existing connections** on the Connections screen, and complete the connection wizard.

Dial-up

When you use your device to dial up to your ISP and connect to the Internet, you will be billed by the number of minutes that you use.

To set up a dial-up connection to your ISP

To establish a dial-up connection on your device, you need the same settings that you normally use when you dial up from your computer. This includes the ISP server phone number, your user name and password.

1. Tap **Start > Settings > Connections** tab > **Connections**.
2. Under **MEdia Net**, tap **Add a new modem connection**.
3. On the Make New Connection screen, enter a name for the connection.
4. In the **Select a modem** list, select **Cellular Line**, then tap **Next**.
5. Enter the ISP server phone number, then tap **Next**.
6. Enter your user name, password, and any other information required by your ISP.
7. Tap **Finish**.

Work network connections

A Virtual Private Network (VPN) connection allows you to access your company network through your device's Internet connection. Whereas a proxy connection lets you access the Internet using an existing connection to your corporate or WAP network.

To set up a connection to a private network

1. Obtain the following information from your network administrator:
 - Server phone number
 - User name
 - Password
 - Domain (and other required settings, such as IP address)

2. Tap **Start > Settings > Connections** tab > **Connections**.
3. In **My Work Network**, follow the instructions for each type of connection.
4. Complete the connection wizard, then tap **Finish**.

Start a data connection



After setting up a connection such as GPRS or ISP dial-up on your device, you can now connect your device to the Internet. The connection is started automatically when you begin using a program that requires an Internet connection. For example, when you start Opera Browser to browse the Internet, your device connects automatically.

To manually start a data connection

If you have set up multiple types of connections on your device, you can manually start a connection.

1. Tap **Start > Settings > Connections** tab > **Connections**.
2. Tap **Manage existing connections**.
3. Tap and hold the name of the desired connection, then tap **Connect**.

To disconnect the GPRS connection

Tap the **Comm Manager** icon () on the Today screen, then tap the **Data Connection** button ().

9.3 Using VueFLO

VueFLO lets you scroll through Web pages by simply tilting your device.

To adjust VueFLO settings

1. Tap **Start > Settings > System** tab > **VueFLO**.
2. Select the **Browser** where VueFLO can be activated.



Note The **Browser** setting is only available when you have both Internet Explorer Mobile and Opera Browser in your device.

2. Adjust the **Sensitivity** level, then tap **OK**.

Tip Tap **Tutorial** to learn how to use VueFLO.

To use VueFLO

1. With the Web browser opened, press  on the device.
2. Tilt the device to the direction you want to scroll to. For example, to scroll down on a Web page, tilt the top of the device towards you; To scroll up, tilt the top of the device away from you.

- Notes**
- To deactivate VueFLO, press  again.
 - You can also press and hold  to use VueFLO. Once you let go of the button, VueFLO will be deactivated.

9.4 Internet Explorer Mobile

Internet Explorer is a full-featured Internet browser, optimized for use on your device.

To start Internet Explorer

- Tap **Start > Internet Explorer**.

To set a Home page

1. In the address bar on top of the Internet Explorer screen, enter the desired Web page address. Tap  to open the Web page.
2. Tap **Menu > Tools > Options > General** tab.
3. Do one of the following:
 - To use the displayed page as the Home page, tap **Use Current**.
 - To use the default Home page, tap **Use Default**.

Tip To go to your Home page, tap **Menu > Home**.

To transfer favorites from your PC

You can transfer the favorites you have stored on your PC to your device by synchronizing the Internet Explorer favorites on your PC with your device.

1. In ActiveSync on your PC, on the **Tools** menu, click **Options**, and select **Favorites**.
2. In Internet Explorer on your PC, click **Favorites > Add to Favorites** and save or move favorite links to the Mobile Favorites subfolder in the Favorites list.

3. Connect your device to your PC. If synchronization does not start automatically, click **Sync**.

To add a favorite

1. In Internet Explorer Mobile, go to the page you want to add.
2. Tap and hold the page, and tap **Add to Favorites**.
3. Confirm or change the name, and select a folder for storing the favorite.
4. Tap **Add**.

To delete a favorite or folder

1. In Internet Explorer Mobile, tap **Menu > Favorites > Add/Delete** tab.
2. Select the item you want to delete, and tap **Delete**.

To change the size of text on Web pages

- In Internet Explorer Mobile, tap **Menu > Zoom**, and tap the size you want.

To change how Web pages fill the screen

1. In Internet Explorer Mobile, tap **Menu > View**.
2. Tap one of the following:
 - **One Column.** Arranges the content into one column that is as wide as the screen. This means that you will rarely have to scroll horizontally.
 - **Default.** Maintains a layout similar to what you see on a desktop computer, but it makes items smaller and arranges the content so that you can see most of it without having to scroll horizontally.
 - **Desktop.** Keeps the same layout and size as on a desktop computer, which will require both horizontal and vertical scrolling.

To clear the History list

1. In Internet Explorer Mobile, tap **Menu > Tools > Options > Memory** tab.
2. Tap **Clear History**.

To save a picture from a Web page

1. In Internet Explorer Mobile, tap and hold the picture, and tap **Save Image**.
2. Do one of the following:
 - To save the picture in **My Pictures** on your device, tap **Yes**.
 - To save the picture in another location, such as a storage card, tap **Save As**.

To delete temporary Internet files

Your device temporarily stores Web pages that you frequently visit or have visited recently to speed up the display of these Web pages when you access them. You may want to delete these files to free storage space.

1. In Internet Explorer Mobile, tap **Menu > Tools > Options > Memory** tab.
2. Tap **Delete Files**. All pages stored on your device, including offline favorites content, will be deleted.

To set up Internet security settings

Cookies are small files containing information about your identity and preferences so that a page can tailor information to your needs. The page sends the file, and it is stored on your device.

1. In Internet Explorer Mobile, tap **Menu > Tools > Options > Security** tab.
2. To prevent Internet Explorer Mobile from accepting any cookies, clear the **Allow cookies** check box.
3. Select the check boxes for the other security options you want, and tap **OK**.

9.5 Opera Browser

Opera Browser is another full-featured Web browser optimized for use on your device.

To open Opera Browser

- Tap **Start > Opera Browser** or press  on your device.



To use Opera Browser

These are some of the most common tasks that you carry out on the Opera Browser screen while surfing the Internet.

1. To go to another Web site, enter the URL address of the Web site in the address bar at the top of the screen. Tap the down arrow (▼) to choose one Web site from previously entered addresses.
2. Tap () to go to the Web address you entered.



Opera Browser

3. Tap () to go back to the previous page.
4. Tap () to refresh the Web page on the screen.
5. Tap **Action > Go to homepage** to go back to the Home page.
6. Tap **Action > Bookmark this page** to add the current Web page to the Bookmarks folder. To open a Web site from the Bookmarks folder, tap **Action > Go to** and then select the Web site you want to open from the Bookmarks folder.

- Tips**
- To open a new browser window, tap **Menu > Windows > New window**.
 - To set browser display preferences, tap **Menu > Display**.
 - To set browser general, history, network, and other options, tap **Menu > Tools > Settings**.
 - To learn more about how to use the Opera Browser, tap **Menu > Tools > Help**.

9.6 Using Bluetooth

Bluetooth is a short-range wireless communications technology. Devices with Bluetooth capabilities can exchange information within a distance of about 10 meters without requiring a physical connection. You can even beam information to a device in a different room, as long as it is within the Bluetooth signal coverage range.

Bluetooth can be used in the following ways:

- Beam information, such as files, appointments, tasks, and contact cards, between devices that have Bluetooth capabilities.
- Synchronize information between your device and computer via Bluetooth.
- Use a Bluetooth-enabled headset (or other Bluetooth-enabled hands-free device such as a car kit) with your device for hands-free phone conversations.
- Use a Bluetooth service. Once you connect to another device or computer using Bluetooth, you can locate and use any of the services available on that device.
- Create a connection between your device and another Bluetooth-enabled phone to use that phone as a modem.

Note Normally, you will need another phone as a modem only if your Pocket PC device has no integrated phone capability.

Bluetooth modes

Bluetooth on your device operates in three different modes:

- **On.** Bluetooth is turned on. Your device can detect other Bluetooth-enabled devices, but not vice versa.
- **Off.** Bluetooth is turned off. In this mode, you can neither send nor receive information using Bluetooth. You might want to turn Bluetooth off at times in order to conserve battery power, or in situations where using a wireless device is prohibited, such as on board an aircraft and in hospitals.
- **Visible.** Bluetooth is turned on, and all other Bluetooth-enabled devices can detect your device.

Note By default, Bluetooth is turned off. If you turn it on, then turn off your device, Bluetooth also turns off. When you turn on your device again, Bluetooth automatically turns on.

To turn Bluetooth on and make your device visible

1. On your device, tap **Start > Settings > Connections** tab > **Bluetooth**.
2. Select the **Turn on Bluetooth** and **Make this device visible to other devices** check boxes.
3. Tap **OK**.

Bluetooth partnerships

A Bluetooth partnership is a relationship that you create between your device and another Bluetooth-enabled device in order to exchange information in a secure manner. Creating a partnership between two devices involves entering the same Bluetooth passcode on both devices.

Creating a partnership between two devices is a one-time process. Once a partnership is created, the devices can recognize the partnership and exchange information without entering a passcode again. Make sure that on the two devices, Bluetooth is turned on and in visible mode.

To create a Bluetooth partnership

1. On your device, tap **Start > Settings > Connections** tab > **Bluetooth**.

2. On the **Devices** tab, tap **Add new device**. Your device searches for other Bluetooth devices and displays them in the box.
3. Tap the desired device name in the box.
4. Tap **Next**.
5. Specify a passcode to establish a secure connection. The passcode can be 1 up to 16 characters.
6. Tap **Next**.
7. Wait for the paired device to accept the partnership. The receiving party needs to enter the same passcode that you specified.
8. The name of the paired device is then displayed. You may edit and enter a new name for that device.
9. Select the check boxes of services that you want to use from the paired device.
10. Tap **Finish**.

To accept a Bluetooth partnership

1. Ensure that Bluetooth is turned on and in visible mode.
2. Tap **Yes** when prompted to establish a partnership with the other device.
3. Enter a passcode (the same passcode that is entered on the device requesting the partnership) to establish a secure connection. The passcode must be between 1 and 16 characters.
4. Tap **Next**.
5. Tap **Finish**. You can now exchange information with the paired device.

To rename a Bluetooth partnership

1. Tap **Start > Settings > Connections** tab > **Bluetooth**.
2. Tap and hold the partnership on the **Devices** tab.
3. On the shortcut menu, tap **Edit**.
4. Enter a new name for the partnership.
5. Tap **Save**.

To delete a Bluetooth partnership

1. Tap **Start > Settings > Connections** tab > **Bluetooth**.
2. Tap and hold the partnership on the **Devices** tab.
3. Tap **Delete**.

Connect a Bluetooth hands-free or stereo headset

For hands-free phone conversations, you can use a Bluetooth hands-free headset such as a car kit with your device.

Your device also supports A2DP (Advanced Audio Distribution Profile) which is for stereo audio over Bluetooth. This means that you can use a Bluetooth stereo headset with your device for hands-free phone conversations as well as for listening to stereo music. Make sure that your stereo headset also supports A2DP.

Just like when connecting to any Bluetooth device, you also need to enter a passcode when connecting to a Bluetooth hands-free or stereo headset. The passcode is fixed and cannot be changed on a Bluetooth headset. Before you connect it to your device, check for the proper passcode in the manufacturer's documentation.

To connect a Bluetooth hands-free or stereo headset

1. Make sure that both your device and the Bluetooth headset are turned on and within close range, and that the headset is visible. Refer to the manufacturer's documentation to find out how to set the headset in visible mode.
2. Tap **Start > Settings > Connections** tab.
3. Tap **Bluetooth > Devices** tab > **Add new device**. Your device searches for other Bluetooth-enabled devices and displays them in the list.
4. Tap the name of the Bluetooth headset, then tap **Next**.
5. Enter the passcode of the Bluetooth headset, then tap **Next**.
6. Make sure the **Hands Free** check box is selected.

If you have a Bluetooth stereo headset, also make sure the **Wireless Stereo** check box is selected.



7. Tap **Finish**.

Note If the Bluetooth stereo headset becomes disconnected, turn the headset on and repeat steps 1 to 3 above. Tap and hold the name of the Bluetooth stereo headset and tap **Set as Wireless Stereo**.

Warning! After pairing the device and the Bluetooth headset or refreshing the pairing, the headset volume is automatically set to the highest volume. It is recommended to lower the volume of the headset first before using it.

Beam information using Bluetooth

You can beam information, such as contacts, calendar items, and tasks, as well as files from your device to your computer or to another Bluetooth-enabled device.

Note If your computer does not have built-in Bluetooth capability, you need to connect and use a Bluetooth adapter or dongle on your computer.

To beam information from your device to a computer

1. Turn on Bluetooth on your device, and make your device visible. For information about this, see “To turn Bluetooth on and make your device visible.”
2. You also need to set Bluetooth on your computer to visible mode. Do one of the following:
 - If your computer has Windows XP SP2 and your computer’s built-in or external Bluetooth adapter is supported by Windows XP SP2, open **Bluetooth Devices** from the Control Panel. Click the **Options** tab, then select the **Turn discovery on** and the **Allow Bluetooth devices to connect to this computer** options.

- If the Bluetooth adapter on your computer was installed using a third-party provided driver, open the Bluetooth software that came with the Bluetooth adapter. This software varies by manufacturer, but in most cases, you will find a **Bluetooth Configuration** utility which you can open from the Control Panel. After Bluetooth Configuration opens, click the **Accessibility** tab, then select **Let other Bluetooth devices to discover this computer**. Refer to the Bluetooth adapter's documentation for more information.
3. Create a Bluetooth partnership between the two devices. For information about creating a partnership, see "Bluetooth partnerships."
After a partnership has been created successfully, your computer is ready to receive Bluetooth beams.
 4. On your device, tap and hold an item to beam. The item can be an appointment in your calendar, a task, a contact card, or a file.
 5. To beam a contact, tap **Menu > Send Contact > Beam**.
To beam other types of information, tap **Menu > Beam [type of item]**.
 6. Tap the device name to which you want to send the beam.
 7. If you beamed an Outlook item and it is not automatically added to Outlook, select **File > Import and Export** in Outlook to import it.

To beam information to a Bluetooth-enabled device such as another Pocket PC, follow steps 3 to 6 in the above procedure.

Note If the computer or device you want to beam to does not appear in your device's Bluetooth list, make sure that its Bluetooth is turned on and set to visible mode.

To receive a Bluetooth beam

Your device will not detect and notify you of incoming Bluetooth beams unless you set it up to do this.

1. Tap **Start > Settings > Connections** tab > **Beam**.
2. Select the **Receive all incoming beams** check box.
3. Make sure your device is turned on, visible, and within close range of the device that is beaming the information.
4. When prompted to receive an incoming beam, tap **Yes** to receive the beamed information.

Bluetooth Explorer and Bluetooth file sharing

Bluetooth Explorer searches for other Bluetooth devices that have file sharing enabled and lets you access their Bluetooth shared folder. You can copy files from and to their shared folder, and create subfolders in it. When you enable **Bluetooth file sharing** on your device, other Bluetooth-enabled devices will also be able to access your Bluetooth shared folder.

To enable Bluetooth Explorer and Bluetooth file sharing on your device

1. Tap **Start > Settings > Connections** tab > **Bluetooth > FTP** tab.
2. Select the **Enable Bluetooth Explorer** check box. This makes the **/Bluetooth** device folder visible in the File Explorer.
3. Select the **Enable File Sharing** check box.

You can use the default Bluetooth shared folder, or tap **Browse** to use another folder as your shared folder.

To use Bluetooth Explorer

1. Bluetooth Explorer is integrated with the File Explorer program. You can open it by tapping **Start > Programs > Bluetooth Explorer** or by tapping the Down arrow ▼ on the upper-left of File Explorer then tapping **Bluetooth**.
2. Bluetooth Explorer then scans for other Bluetooth devices that have file sharing enabled. From the list, tap to select a Bluetooth device you want to connect to. You may need to enter a passcode in order for you to connect to the selected device.



3. If there are files contained in the Bluetooth shared folder on the other device, you will be able to see them on the Bluetooth Explorer screen. Select one or more files, then tap **Menu > Edit** and choose to cut or copy the files.
4. Tap **Up** twice.
5. Navigate to the folder where you want to paste the files on your device, then tap **Menu > Edit > Paste**.

Use the device as a Bluetooth modem

You can connect your device to a notebook or desktop computer through Bluetooth and use the device as a modem for the computer.

Note If your computer does not have built-in Bluetooth capability, you need to connect and use a Bluetooth adapter or dongle on your computer.

For the computer to use the Internet connection of your device, activate Internet Sharing on your device, then set up a Bluetooth Personal Area Network (PAN) between the computer and your device.

1. On your device, turn on Bluetooth and set it to visible mode.
2. Initiate a Bluetooth partnership from your device by following the steps in "To create a Bluetooth partnership."

Alternatively, you can initiate a Bluetooth partnership from the computer by following these steps (based on Windows XP SP2):

- a. In the Control Panel or System Tray, double-click the **Bluetooth Devices** icon.
- b. In the Bluetooth Devices window, click **Add**.

- c. The Add Bluetooth Device Wizard opens. Select the **My device is set up and ready to be found** check box, then click **Next**.
 - d. The wizard then detects your device and displays its name in the dialog box. Select the device name, then click **Next**.
 - e. Select **Let me choose my own passkey**, then enter a passcode (1 up to 16 digits) that will serve as an identification number for establishing a secure connection between your device and the computer. Click **Next**.
 - f. A confirmation message then appears on your device. Tap **Yes** to accept the connection, enter the same passcode, then tap **Next**.
 - g. On the computer, click **Finish** to exit the wizard.
 - h. On your device's Partnership Settings screen, you can change the display name for the computer, then tap **Finish**.
3. Now, open the Internet Sharing program on your device. Tap **Start > Programs > Internet Sharing**.
4. Select **Bluetooth PAN** as the **PC Connection**.
5. From the **Network Connection** list, select the name of the connection that your device uses to connect to the Internet.
6. Tap **Connect**.
7. On your computer, set up a Bluetooth Personal Area Network (PAN) with your device:
 - a. Tap **Start > Control Panel > Network Connections**.
 - b. Under **Personal Area Network**, click the **Bluetooth Network Connection** icon.
 - c. Under **Network Tasks**, click **View Bluetooth network devices**.
 - d. In the Bluetooth Personal Area Network Devices dialog box, select your device, then click **Connect**.
8. On the Internet Sharing screen on your device, check if a connected status is displayed, which indicates that your computer has been successfully connected to the Internet using your device as a Bluetooth modem.

Use another Bluetooth phone as a modem

You can use another phone that has Bluetooth as a modem for your device to browse the Internet or to transfer other information.

To do this, create a Bluetooth modem connection on your device and then send information to the phone by using Bluetooth. The phone relays the information over the mobile phone network and then sends back to your device any information that you had requested over the connection.

Once you create a modem connection to the Bluetooth phone, you can reuse it whenever you want to use the phone as a modem. Make sure that Bluetooth is turned on and visible mode is enabled on both your device and the phone, and that the two are within close range.

Note Normally, you will need another phone as a modem only if your Pocket PC device has no integrated phone capability.

To use a Bluetooth phone as a modem for your device

1. On your device, tap **Start > Settings > Connections** tab > **Connections**.
2. Tap **Add a new modem connection**.
3. Enter a name for the connection.
4. In the **Select a modem** list, tap **Bluetooth**.
5. Tap **Next**.
6. If the phone appears in the **My Connections** list, skip to step 11.
7. If the phone does not appear in the **My Connections** list, tap **Add new device**, and follow the remaining steps.
8. Select the phone from the list and tap **Next**.
9. Enter a passcode and tap **Next**.
10. Enter the same passcode on the phone and tap **Finish**.
11. In the **My Connections** list on your device, select the phone and tap **Next**.
12. Enter the phone number to dial for this connection and tap **Next**.
13. Enter the required logon information for this connection and tap **Finish**.

9.7 Using Internet Sharing

Internet Sharing connects your PC or notebook computer to the Internet by using your device's data connection (GPRS or EDGE, for instance). You can choose to connect via USB or Bluetooth.

Follow the procedure in this section to set up your device as a USB modem. To learn how to set up your device as a Bluetooth modem, see "Use the device as a Bluetooth modem" in this chapter.

- Notes**
- Make sure your device has a SIM card installed, and you have set up a GPRS or phone dial-up modem connection on your device. If your device has not been set up with a data connection yet, tap **Menu > Connection Settings** on the Internet Sharing screen. For more information about setting up a GPRS or dial-up connection, see "Connecting to the Internet."
 - If you want to use a USB cable connection, you must first install Microsoft ActiveSync version 4.5 or later on the computer.
 - Before using Internet Sharing, disable ActiveSync on your computer.

To set up your device as a USB modem

1. On your device, tap **Start > Programs > Internet Sharing**.
2. In the **PC Connection** list, select **USB**.
3. In the **Network Connection** list, select the name of the connection that your device uses to connect to the Internet.
4. Plug in the USB cable between your device and the computer.
5. Tap **Connect**.



To end the Internet connection

- On the Internet Sharing screen, tap **Disconnect**.

Chapter 10

Using GPS

10.1 Guidelines and Preparation for Using GPS

10.2 Downloading Satellite Data via QuickGPS

10.3 Using GPS Software

10.4 GPS Controls



10.1 Guidelines and Preparation for Using GPS

- Do not operate the GPS system while driving.
- The plotted GPS route is only for driving references. It should not affect actual driving behavior.
- Please use the GPS system cautiously. Users shall be liable for any damages resulting from negligent operation of the system.
- When using inside a vehicle, please utilize the car holder to mount the Pocket PC securely in place. Please avoid the areas shown in the following diagram:

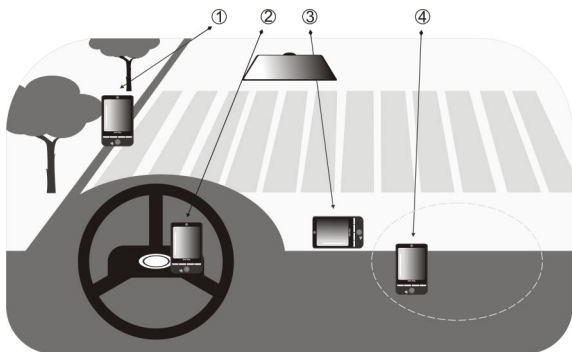

1. Do not place where it will block the driver's vision.
 2. Do not place at where the air bags are.
 3. Do not place anywhere in the vehicle without securing in the holder.
 4. Do not place where the air bags could deploy.
- The GPS signal cannot pass through solid non-transparent objects. Signal reception may be affected due to obstructions such as high-rise buildings, tunnels, bridges, forests, bad weather (rainy or cloudy days), etc.

- Signal reception may be affected by obstructions such as high-rise buildings, tunnels, bridges, forests, weather (rainy or cloudy days), etc. If the vehicle's visor contains metal, it will be difficult for the GPS signal to pass through. To have better signal reception, try connecting your device to an external GPS antenna.
- The Global Positioning System (GPS) is built and operated by the US Defense Department. The Department is responsible for the accuracy and maintenance of the system. Any changes that the Department makes may affect the accuracy and function of the GPS system.
- Wireless communication products (such as mobile phones or radar-detecting devices) may interfere with the satellite signal, resulting in unstable signal reception.
- Please do not leave your Pocket PC in the vehicle and expose to direct sunlight to avoid overheating the battery that could pose damage to the device or risk to the vehicle.

10.2 Downloading Satellite Data via QuickGPS

Before you start to use your device for GPS navigation, open the **QuickGPS** program first to download Ephemeris data (current satellite position and timing information) onto your device. This data is needed to determine the GPS position of your current location.

QuickGPS downloads Ephemeris data from a Web server, instead of from the satellites, using the Internet connection on your device, which can be via ActiveSync, Wi-Fi, or GPRS. This significantly speeds up the time for determining your GPS position.

To open QuickGPS

- Tap the QuickGPS icon () on the Today screen; or
- Tap **Start > Programs > QuickGPS**.

To download data

- Tap **Download** on the QuickGPS screen.



On the screen, initially, you will see the **Valid time** of the downloaded data to be 3 days. As days and time pass, the remaining days and time of validity will be shown.

To speed up GPS positioning, download the latest Ephemeris data when the validity of the data expires.

Download options

To configure download times, tap **Menu > Options** and choose from the following options:

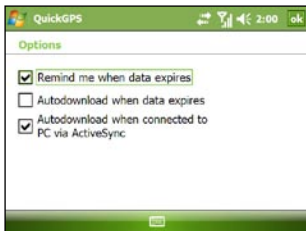

- **Remind me when data expires.** Enables your device to display a reminder message when the validity of the Ephemeris data has expired.

When you see the reminder message, tap **Menu** to dismiss the reminder or to set the snooze time so that you will be reminded again. Tap **OK** to open the QuickGPS program and download the latest data.

- **Autodownload when data expires.** Allows Ephemeris data to be automatically updated onto your device when the data has expired.
- **Autodownload when connected to PC via ActiveSync.** Allows Ephemeris data to be automatically downloaded via ActiveSync to your device when your device is connected to your computer. Your computer must be connected to the Internet in order to download data.

Note The Ephemeris data are stored on HTC Web servers. QuickGPS is preconfigured to connect to these servers.

10.3 Using GPS Software

Your device is preinstalled with the GPS software.

To open the GPS software

- Tap **Start > Programs** then tap its program icon; or

For information about using the GPS software, see Help on your device.

10.4 GPS Controls

When a map or menu is shown on the GPS software, use the following controls on your device to navigate:

- On the Map Browser screen, press NAVIGATION up to zoom in, press NAVIGATION down to zoom out on a map.
- Use the NAVIGATION CONTROL to scroll through items in a menu. Press the CENTER OK button to select a menu item and open the corresponding screen.

Chapter 11

Using Windows Live

11.1 Windows Live Mobile

11.2 Live Messenger

11.3 Sending Photos to Your Windows Live Space

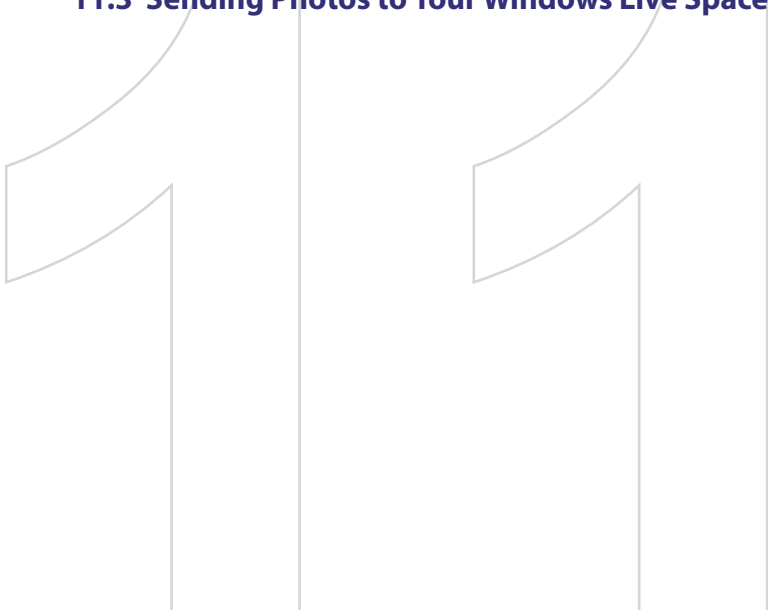

11.1 Windows Live Mobile

Windows Live Mobile gives you full Internet experience on your device. It helps you to find information, pursue your interests, and get in touch with friends and family on the Internet easier.

Windows Live Mobile offers the following key features:

- **Live Search Bar**, which lets you search for information on the Web.
- **Live Messenger**, the next generation of MSN Messenger Mobile.
- **Live Mail**, the next generation of Hotmail.
- **Live Search**, which lets you find locations, browse maps, and check for directions.
- **Live Contacts**, your address book for storing Live Mail, Live Messaging, and Hotmail contacts.

Set up Windows Live Mobile

The first time you use Windows Live Mobile, sign in by using your Windows Live ID, which is your Windows Live Mail or Hotmail address, and password.

To set up Windows Live Mobile for the first time

1. Tap **Start > Programs > Windows Live**.
2. Tap **Sign in to Windows Live**.
3. On the next screen, tap the links to read the Windows Live Term of Use and the Microsoft Privacy Statement. After reviewing them, tap **Accept**.
4. Enter your Windows Live Mail or Hotmail address and password, select the **Save password** checkbox, then tap **Next**.
5. Choose whether or not to show Windows Live's search bar and applications on the Today screen then tap **Next**.



6. Choose what information you want to sync online with your device.

If you choose to synchronize **Contacts and Messenger**, your online contacts will be added to the contact list and to Live Messenger on your device.

If you choose to synchronize E-mail, your Windows Live Mail or Hotmail inbox messages will be downloaded to your device.

7. Tap **Next**.
8. After synchronization is complete, tap **Done**.



The Windows Live Mobile interface

On the main interface of Windows Live Mobile, you will see a search bar, navigation bar, and an area where you can customize to show your picture.

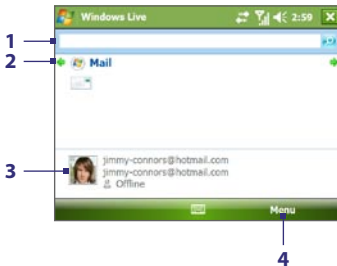

- 1 This is the Live Search Bar.
- 2 Tap the Left or Right arrow to switch between Windows Live Messenger and Sync status.
- 3 Tap to access Windows Live Messenger.
- 4 Tap **Menu** to access and change settings.

If you chose to display the search bar and Windows Live applications on the Today screen when you were setting up Windows Live, you'll see them on the Today screen:

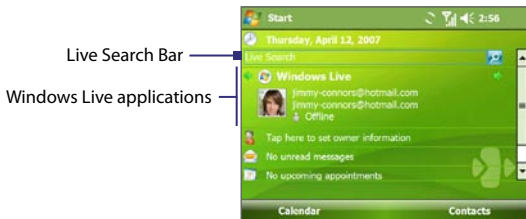

To show or hide them, open Windows Live and tap **Menu > Options > Today screen options**.

Live Search Bar

Use the **Live Search Bar** to easily find information on the Internet. It is integrated in the Windows Live Mobile interface.

To find information on the Internet

1. Enter your keywords in the search bar.
2. Tap  or **Search**. The default Web browser then launches and displays links to related Web sites. The links are organized in categories.



Search results

11.2 Live Messenger

Live Messenger lets you send and receive instant messages online. With this mobile version of Windows Live Messenger, you enjoy many of the same cool features that you get from the desktop version, which include the following:

- Instant messaging via text and voice
- Multiple conversations
- Add emoticons
- Contact list with presence
- Send and receive files including photos
- Change status/display name
- View contacts by online status, groups, and more
- Send messages even when a contact is offline

- Notes**
- Before you can use Live Messenger, your device must be connected to the Internet. For information about setting up an Internet connection, see “Connecting to the Internet” in Chapter 9.
 - You also need to have a data plan from your wireless service provider to use Live Messenger.

Launch the messenger and sign in

To open Live Messenger

Do one of the following:

- Tap **Start > Programs > Messenger**.
- On Windows Live or the Today screen, tap the Left or Right arrow until you see **Messenger**, then tap it.

To sign in and out

1. To sign in, tap **Sign in** on the messenger screen.
2. If this is your first time to sign in, a message appears to inform you that your messenger contacts will be added to the contact list on your device. Tap **OK** to add them.

Signing in may take several minutes, depending on your connection speed.

3. To sign out, tap **Menu > Sign Out**. Your status changes to **Offline**.

Add Windows Live contacts

You can add new Windows Live contacts in Live Messenger or in Contacts.

To add a Windows Live contact in Live Messenger

1. Tap **Menu > Add new contact**.
2. Enter the e-mail address of the contact then tap **OK**.

To add a Windows Live contact in Contacts

1. Tap **Start > Contacts**.
2. Tap **New** then tap **Windows Live**.
3. In the **IM** box, enter the e-mail address of the contact, which can be a Windows Live ID or any other e-mail address.

Tip You can fill in other information about the contact, if desired. This is not absolutely necessary if you will communicate with the contact only through Windows Live Messenger or Live Mail.

4. Tap **OK**.
5. Follow the remaining instructions to add the new contact to your Windows Live contact list.

To delete a contact

1. In the messenger, select the contact and tap **Menu > Contact options > Remove contact**.
2. Choose whether to block the contact.
3. Choose whether to also delete the contact from your device's contact list.
4. Tap **OK**.

Send instant messages

You can send instant messages with emoticons, and even talk by sending a voice clip. While chatting, you can send and receive files directly on a message window. You can also start conversations with several contacts and switch between their message screens, or you can invite participants to join in a conversation.

To start and end conversations

1. In the contact list, select a contact then tap **Send IM** to open a message screen.

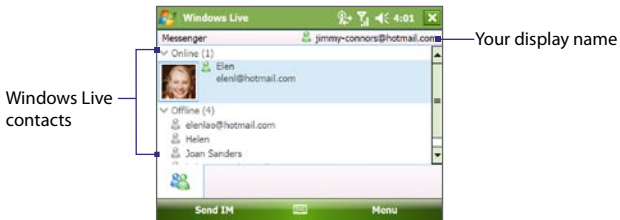

2. Send an instant message. See “To send an instant message with emoticon” for details.
3. To start a conversation with another contact, tap  to go back to the contact list, then select another contact and tap **Send IM** again. Another message screen opens.
4. To switch from one message screen to another, tap the display picture of the contact whom you want to talk to.



Pictures of contacts whom you're talking to

5. To end a conversation with the current contact, tap **Menu > End conversation**.
6. To end all active conversations, tap **Menu > End all conversations**.

To send an instant message with emoticon

1. Select a contact and start a conversation.
2. Enter your text message in the text entry area of the message screen.
3. To add an emoticon, tap **Menu > Add emoticon** then tap an icon from the list of emoticons.
4. Tap **Send**.

- Tips**
- To send a file, tap **Menu > Send**. You can choose to send a picture, voice clip or any file.
 - To invite one or more contacts to the conversation, tap **Menu > Options > Add participant**.

To send a voice message

1. Select a contact and start a conversation.
2. Tap **Voice clip** then start talking.
3. After you have spoken a message, tap **Send**.

Personalize the messenger

While on the contacts list, you can do the following:

- Tap **Menu > Change status** to set your current status (such as Busy, Out to lunch, etc.) so that your contacts will know whether or not you're available.
- Tap **Menu > Change appearance** to change your display name, add a personal message, and add your picture.
- Tap **Menu > Sort by** to organize contacts by online status, groups, name, or e-mail address. You can also hide offline contacts from the contact list.
- Tap **Options** to see more settings.

11.3 Sending Photos to Your Windows Live Space

If you created your own Live Space, you can send pictures from your device to your Live Space.

To upload a picture to your Live Space

1. Tap **Start > Programs > Pictures & Videos**.
2. Select a picture then tap **Send to your space**.



After sending a picture to your Live Space, you can use Internet Explorer to sign into your Live Space and check whether the picture has been successfully uploaded.

To go to your Live Space on your device

1. Tap **Start > Internet Explorer**.
2. In the address bar, enter "**http://spaces.live.com**" then tap .
3. On Mobile Live Space's Web page, tap **Sign in**.



4. On the next Web page, scroll down to the bottom of the page then tap **Your space**.

Wait for your Live Space to be loaded in Internet Explorer. You will see the uploaded picture under **Mobile photos**



Uploaded picture

To go to your Live Space on your computer

1. Open Internet Explorer on your PC.
2. On the address bar, enter "**http://spaces.live.com/**" then press ENTER.
3. In the Windows Live Spaces Web site, click **Go to your space**.
4. Move the mouse pointer over to your Windows Live ID, then click **Sign In**.

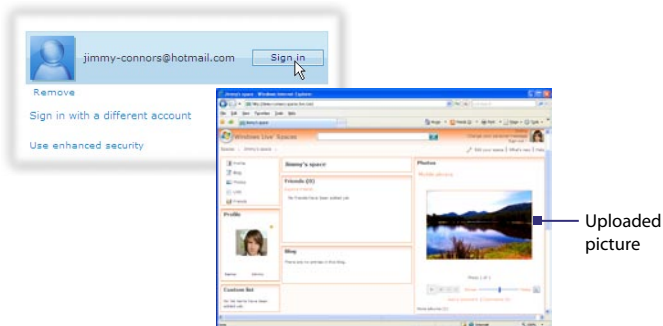

Chapter 12

Experiencing Multimedia

12.1 Using Camera

12.2 Using Pictures & Videos

12.3 Using Windows Media Player Mobile

12.4 Using Streaming Media

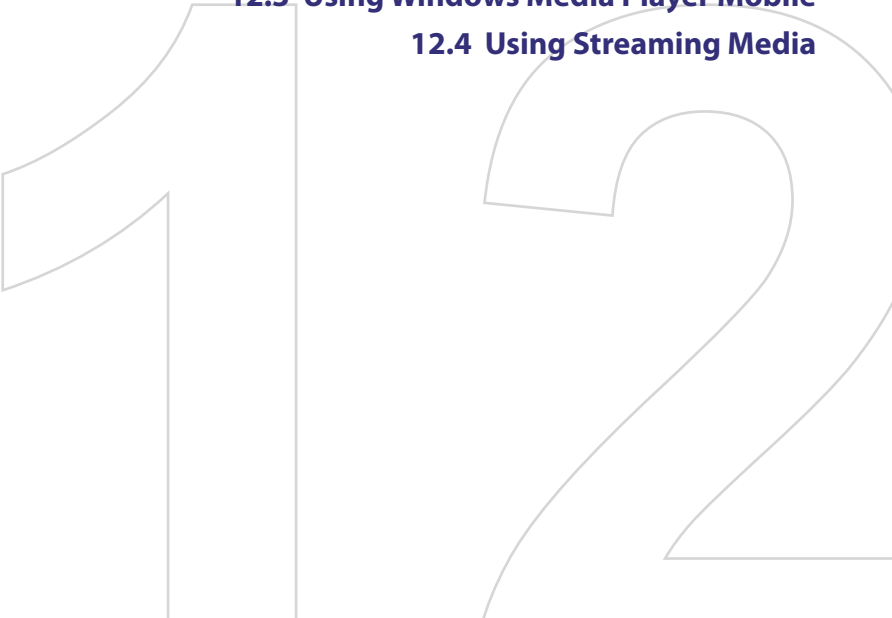

12.1 Using Camera

Taking photos and recording video clips along with audio are easy with your device's built-in camera.

To open the Camera screen

- Press the CAMERA button on your device.



- Tap **Start** > **Programs** > **Camera**; or
- Tap **Start** > **Programs** > **Pictures & Videos** > **Camera** icon; or

To exit the Camera

- Tap the **Exit** icon ().

Capture modes

The camera on your device allows you to capture pictures and video clips by using various built-in modes with flexibility. The Camera mode is set to the Photo capture mode by default. The upper left corner of the screen displays the active capture mode. To switch to other capture modes, do any of the following:

- Tap  or  on the screen.
- Press NAVIGATION left or right.

Current capture mode



The available capture modes of the camera are as follows:

- **Photo:** Captures standard still images.
- **Video:** Captures video clips, with or without accompanying audio.
- **MMS Video:** Captures video clips suitable for sending via MMS.
- **Contacts Picture:** Captures a still image and gives you the option to immediately assign it as a Photo ID for a contact.
- **Picture Theme:** Captures still images and places them within frames.
- **Panorama:** Captures a sequence of still images continuously in one direction, and allows stitching of all the images to create a panoramic view of a scenery.
- **Sports:** Captures a sequence of still images (3, 5, 7, or 10) automatically.
- **Burst:** Captures a sequence of still images (maximum 30) as long as the CAMERA button on the device or the CENTER OK button on the NAVIGATION CONTROL is kept pressed.

File formats supported

Using the above capture modes, the camera in your device captures files in the following formats:



Capture type	Format
Still image	JPEG
Video	MPEG-4 (.mp4)
MMS Video	H.263 baseline (.3gp), MPEG-4 (.mp4)
Panorama / Sports / Burst	JPEG

Camera controls

Use the following device buttons and on-screen controls to take photos or video clips and to modify settings.

The CAMERA and CENTER OK buttons

Press the CAMERA button on the device to open the Camera screen. If already on the Camera screen, you can use either the CAMERA button or the CENTER OK button as the shutter release.

- Press the CAMERA button or the CENTER OK button to take a photo or contacts picture.
- Press the CAMERA button or the CENTER OK button to start recording video; press it again to stop recording.
- Press the CAMERA button or the CENTER OK button each time when taking photos for a picture theme or panorama.
- To take consecutive shots in Sports mode, press the CAMERA button or the CENTER OK button shortly, then move your device to follow the movement of your subject.
- Press and hold the CAMERA button or the CENTER OK button when taking consecutive shots in Burst mode.
- Press the CAMERA button halfway to activate autofocus . Once focused, the indicator changes to  and you will hear two beeping sounds. Press the CAMERA button all the way to take the shot.

The Navigation Control

- Press NAVIGATION up or down to increase or decrease the zoom level.
- Press NAVIGATION left or right to go to the previous or next sequential capture mode.

On-screen controls and indicators

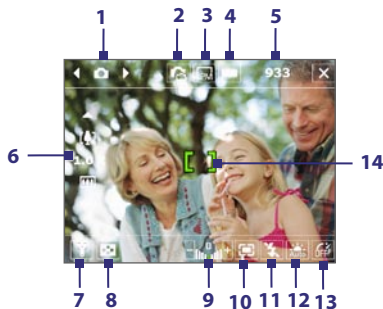
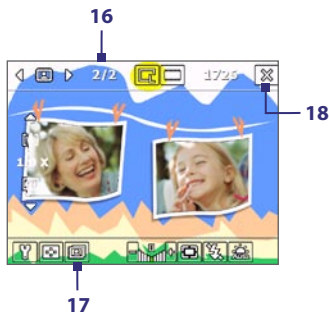

Photo mode













Video mode



Picture Theme mode

- 1 Mode Switching control.** Tapping the left/right arrow (◀/▶) on the screen allows you to switch the capture mode.
- 2 Camera Switching control.** The camera icon (📷/📷/📷) indicates the current camera being used. Tap to toggle between the different cameras.
- 3 Resolution.** The resolution icon (📷/📷/📷/📷/📷) indicates the current resolution. Tap to toggle among the different resolutions.
- 4 Storage.** Tap to toggle between saving captured photos or video clips on the device memory (📷), on the memory card (📷), on the SIM card (📷) (MegaSIM card only), or on the Microdrive (📷).
- 5 Remaining information indicator.** In Photo, Contacts Picture, Picture Theme, Panorama, Sports, and Burst modes, this shows the remaining, available shots of pictures based on current settings. In Video and MMS Video modes, this shows the remaining duration that can be recorded. While recording video, this shows the recorded duration.
- 6 Zoom control.** Tapping the up/down arrow (▲/▼) or tapping 📷/📷 on the screen allows you to zoom in or zoom out.
- 7 Camera Settings.** Tap the **Tool** icon (🔧) to open the Camera Settings screen.
- 8 Picture Viewer.** Tap the **Viewer** icon (📷) to view the picture or video in Pictures & Videos.

- 9 **Brightness.** Tapping the minus/plus icon ( / ) decreases or increases the brightness level.
- 10 **Metering Mode.** Tap to toggle the metering mode between **Center Area** () and **Average** ()
- 11 **Flash Light.** Tap to turn on or off the flash light that is located at the back of your device. When the flash light is on, the camera gives off a flash when taking photos.
- 12 **White Balance.** Tap to toggle among the different white balance settings: Auto ()^{Auto}, Daylight ()^{Daylight}, Night ()^{Night}, Incandescent ()^{Incandescent}, and Fluorescent ()^{Fluorescent}.
- 13 **Self-timer.** Tap to set the Self-timer to 2 seconds, 10 seconds, or off when in the Photo or Contacts Picture mode. When you press the CENTER OK button or the CAMERA button to capture a still image, it starts to count down, and then captures a still image after the assigned time (2 seconds or 10 seconds).
- 14 **Autofocus indicator.** Shows when autofocus is activated. When in **Panorama** or **Picture Theme** mode, autofocus will be used for each shot. When in **Sports** or **Burst** mode, only the first shot will use autofocus.
- 15 **Recording indicator.** This shows a red, blinking indicator while video recording is in progress.
- 16 **Progress indicator.** In Picture Theme, Panorama, Sports, and Burst modes, this shows the total number of consecutive shots.
- 17 **Template Selector icon.** In Picture Theme mode, tap  to toggle among the different templates.
- 18 **Exit.** Tap the **Exit** icon () to exit the Camera program.

Still image capture modes

While using Still Image capture modes, such as **Photo**, **Contacts Picture**, **Picture Theme**, **Panorama**, **Sports**, and **Burst**, you can capture still image(s) by pressing the CAMERA button on the device or the CENTER OK button on the NAVIGATION CONTROL. Still images will be saved in JPEG format.

While capturing an image in the Picture Theme capture mode, you can select a preset template. To view and select from different templates, tap  on the Camera screen. Depending on the chosen template, one or more photos may need to be taken for the template.

Video capture mode

While using the **Video** capture mode, you can press the CAMERA button or the CENTER OK button to start recording a video clip (with audio if desired). To stop recording, press the CAMERA button or the CENTER OK button again. Your device displays the first frame of the captured video clip by default on the Review screen.

Before you capture a video clip, you can specify the desired length of recording in terms of time or file size on the Camera Settings screen.

Video clips will be saved in MPEG-4 format.

MMS Video capture mode

The **MMS Video** capture mode makes it convenient for you to capture a video file and then send it via MMS. Press the CENTER OK button or the CAMERA button to start recording a video clip (with audio if desired). To stop recording, press the CENTER OK button or the CAMERA button again.

The recording length of MMS video is fixed. Recording automatically stops when the preset length is reached. However, you can manually stop recording the video anytime. The time indicator at the upper right side of the Camera screen indicates the time limit.

You can specify the capture format to be either H.263 or MPEG-4 on the Camera Settings screen; however, the ideal format for MMS is H.263 (3GPP). After you capture the video file, tap  on the Review screen to send the file through MMS.

The Review screen

After taking a still image or recording a video clip, you can view the image or video clip on the **Review screen**. In addition, you can tap the icons at the bottom of the Review screen to delete a captured image or video, send it via e-mail or MMS, and more.

Review screen icons





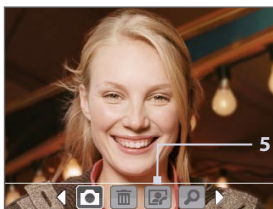

Photo, Video, MMS Video, Panorama, and Picture Theme modes

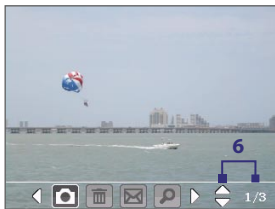

Contacts Picture mode





Sports and Burst modes

- 1 Back.** Tap  to go back to Camera screen.
- 2 Delete.** Tap  to remove the captured image or video.
- 3 Send.** Tap  to send via e-mail or MMS.
- 4 View.** Tap  to view the image in the Pictures & Videos program, or play the captured video in Windows Media Player Mobile.
- 5 Assign to Contacts.** Tap  to associate the photo to a selected contact.

- 6 Browse.** After you have taken photos in Sports or Burst mode, the total number of consecutive shots is shown in the lower right corner of the Review screen. Tap the up/down arrow () to browse through the sequence of photos.

To change the display duration of the Review screen

1. Tap  to open the Camera Settings screen.
2. On the Camera Settings screen, tap . The Advanced menu then appears.
3. Tap **Review Duration**, then tap the desired time length for displaying captures on the Review screen.

Zooming

While capturing a still image or a video clip by using the camera, you can zoom in to make the object in focus move closer, and you can zoom out to make the object move farther away. In all capture modes, press NAVIGATION up on your device, or tap the triangular Up arrow above the Zoom Ratio indicator, to zoom in your subject. When the zooming limit is reached, you will hear a beep. To zoom out, press NAVIGATION down, or tap the Down arrow. The camera zoom range for a picture or a video clip depends on the capture mode and capture size. The following is a summary.

Capture mode	Capture size setting	Zoom range
Photo	3M (2048 x 1536)	No zooming available
	2M (1600 x 1200)	No zooming available
	1M (1280 x 1024)	No zooming available
	Large (640 x 480)	1.0x to 4.0x
	Medium (320 x 240)	1.0x to 8.0x
	Small (160 x 120)	1.0x to 10.0x
Video	CIF (352 x 288)	No zooming available
	Large (320 x 240)	No zooming available
	Medium (176 x 144)	1.0x to 2.0x
	Small (128 x 96)	1.0x to 2.0x

Capture mode	Capture size setting	Zoom range
MMS Video	Medium (176 x 144)	1.0x to 2.0x
	Small (128 x 96)	1.0x to 2.0x
Contacts Picture	Large (640 x 480)	1.0x to 4.0x
	Medium (320 x 240)	1.0x to 8.0x
	Small (160 x 120)	1.0x to 8.0x
Picture Theme	Determined by the current template	Depends on the size of the template currently loaded
Panorama	Large (640 x 480)	1.0x to 4.0x
	Medium (320 x 240)	1.0x to 8.0x
	Small (160 x 120)	1.0x to 8.0x
Sports	Large (640 x 480)	1.0x to 2.0x
	Medium (320 x 240)	1.0x to 8.0x
Burst	1M (1280 x 1024)	No zooming available
	Large (640 x 480)	1.0x to 2.0x
	Medium (320 x 240)	1.0x to 8.0x

Note The capture sizes available for certain capture formats also vary from one capture mode to another. The zoom range has been calculated based on the following ratio:

- 1.0x = normal size (no zooming)
- 2.0x = double enlargement
- 4.0x = four times enlargement
- 8.0x = eight times enlargement
- 10.0x = ten times enlargement

The Camera Settings screen



Camera Settings screen in Photo mode

When you tap the icons at the bottom of the Camera Settings screen, different menus will appear. Some menus and options may be available only in certain capture modes.

To navigate the Camera Settings screen

You can either tap on-screen or press the Navigation Control buttons to navigate the Camera Settings screen.

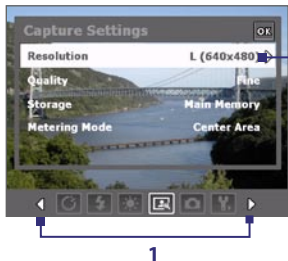

- 1 Tap an icon to display the desired menu.
Alternatively, when using the Navigation Control, press NAVIGATION down first. The background of the icon bar at the bottom then changes color. Now, press NAVIGATION left/right or tap the left/right arrow (◀/▶) to navigate to the icon of the desired menu. Once the desired menu is displayed, press NAVIGATION up.
- 2 Tap an option on the menu to open a submenu of available settings.
Alternatively, press NAVIGATION up/down to select an option, then press NAVIGATION right to open its submenu.

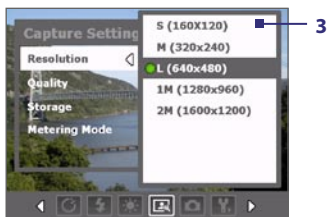

- 3 Tap or press the CENTER OK button to select a setting and close the submenu.

Alternatively, press NAVIGATION up/down to select a setting, then press NAVIGATION left to close the submenu.

For more information about the different menus and settings, see the succeeding sections.



Self-timer menu

- **Self-timer.** Select the Self-timer option for capturing images: **Off**, **2 seconds**, or **10 seconds**. Selecting 2 seconds or 10 seconds delays the capturing by the specified time after you press the CAMERA button or the CENTER OK button.



Template menu

- **Template.** Select a template (in Picture Theme mode only).



Panorama Settings menu

- **Direction.** Choose in what direction images will be stitched in a panorama.
- **Stitch Count.** Select the desired number of snapshots to be taken and stitched into a panorama.
- **Auto Stitch.** When the Auto Stitch is **On**, the camera automatically stitches snapshots into one single file. If Auto Stitch is **Off**, the snapshots are saved as separate files.



Sports Settings menu

- **Snapshots.** Select the number of consecutive shots to capture.



Flash Light menu

- **Flash Light.** Set this option to **On** to turn on the flash light (located at the back of your device) so that you can shoot photos or video clips in a dark-lit environment. This also allows the camera to give off a flash when taking photos. The flash light is available for use in all capture modes except in Sports and Burst modes.



Ambience menu

- **White Balance.** Select a white balance setting type such as Fluorescent, Night, etc. to suit your lighting environment.
- **Effect.** Choose a special effect such as Grayscale, Sepia, etc., to apply to your photos or video clips.



Capture Settings menu

- **Resolution.** Select the desired image or video size.
- **Quality.** Select the JPEG image quality level for all captured still images. You can choose from **Basic**, **Normal**, **Fine**, and **Super Fine**.
- **Storage.** Select where you want to save your files. You can either save the files to the main memory or to a storage card.
- **Metering Mode.** Select a metering mode to allow the camera to measure the amount of light in the center and around the image and calculate the best-fit exposure value before capturing. Choose either **Center Area** to measure light using the center area of the image or **Average** to measure light using the area all around the image.



Capture Mode menu

- **Mode.** Switch between different capture modes such as Photo, Video, Contacts Picture, and more. For more information about these modes, see “Capture modes” earlier in this chapter.



Advanced menu



Tap the left/right icon in this bar to switch between the menu pages in the Advanced menu.

Alternatively, when using the Navigation Control buttons, keep pressing down until this bar is selected (bar changes color). Press left/right to switch between the menu pages.

- **Capture Format.** Select the desired file format.
- **Shutter Sound.** Choose whether or not you want the camera to make a shutter sound when you press the CENTER OK button or the CAMERA button to take photos or record video clips.
- **Grid.** Choose whether or not to show a grid on the Camera screen. Showing a grid helps you frame and center your subject more easily and accurately.



- **Keep Backlight.** Choose whether to turn the backlight on or off while using the camera. This overrides your device backlight settings while you are using the camera.

- **Review Duration.** Set a time length for displaying the captured image/video on the Review screen before automatically saving it and returning to the live Camera screen. Select **No Limit** if you do not want to impose a time limit. Select **No Review** to immediately return to the live Camera screen after capturing.
- **Flicker Adjustment.** When taking indoor shots, flicker on the camera screen may be caused by inconsistencies between the vertical scan rate of the camera display and the flicker frequency of fluorescent lighting. To reduce flicker, you can change the flicker adjustment setting to **Auto** or to the proper frequency (**50Hz** or **60Hz**) of the country where your device is being used.
- **Record with Audio.** Select **On** to record audio with the captured video clips. This is selected by default. If you select **Off** and then capture a video clip, it will have no audio.
- **Prefix.** Specify how to name captured images and video clips. When **Default** is selected, the file name of each new captured file is set to "IMAGE" or "VIDEO" followed by a sequential number, for example: IMAGE_001.jpg. You may also choose to name files using either the current **Date** or **Date & Time** as the prefix.
- **Counter.** By default, the newly captured image or video files are named with a prefix and some sequential numbers, such as 001, 002, and so on. To reset the numbering to "001" for your captured files, tap **Reset**.
- **Recording Limit.** Specify the maximum time or file size for recording.
- **Template Folder** (in Picture Theme mode only). By default, templates are stored in the \My Documents\Templates folder on the device's **Main Memory**. If you transferred some templates to a storage card (via File Explorer), set this option to **Main + Card** to specify that templates are located in both the main memory and the storage card.
- **Adjust.** This option allows you to adjust the camera display properties, such as **Contrast**, **Saturation**, **Hue**, and **Sharpness**.

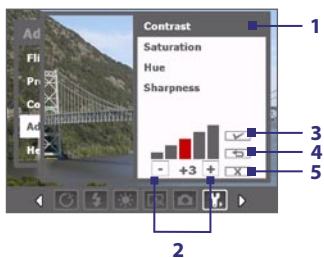

- 1 In the submenu, tap one of the properties to adjust. Alternatively, press NAVIGATION up/down to select a property.
- 2 To increase/decrease the value, tap the plus/minus icon or press NAVIGATION left/right. The live Camera screen on the background immediately displays the effect of changes.
- 3 Tap to save the settings and close the submenu.
- 4 Tap to reset all properties to their default.
- 5 Tap to close the submenu without applying and saving the changes.

12.2 Using Pictures & Videos

The **Pictures & Videos** program collects, organizes, and sorts images and video clips in the following formats on your device.

File Type	File Extensions
Image	*.bmp, *.jpg, *.gif
GIF animation	*.gif
Video	*.avi, *.wmv, *.mp4, *.3gp

You can view the pictures as a slide show, beam them, send them via e-mail, edit them, or set them as the background on the Today screen.

To copy pictures, GIF animation files, and video clips to your device

You can copy pictures, GIF animation files, and video files from your PC and view them on your device.

- Copy the pictures, GIF animation files, and video files from your PC or a storage card to the My Pictures folder on your device. (You can also copy video files to the My Videos folder.)

For more information about copying files from your PC to your device, see ActiveSync Help on your PC.

Note You can also copy pictures, GIF animation files, and video files from your PC to your device using a memory card. Insert the memory card into the memory card slot on your device, then copy the files from your PC to the folder you created on the memory card.

To view pictures

1. Tap **Start > Programs > Pictures & Videos**. The images in the My Pictures folder appear as thumbnails by default.
2. Select a picture and tap **View**. If you cannot find a picture in the default My Pictures folder, go to another folder by tapping the Down arrow (▼).

To play GIF animation files

1. Tap **Start > Programs > Pictures & Videos**.
2. Select a GIF animation file and tap **View**. The GIF Animation program then opens and plays the animation.

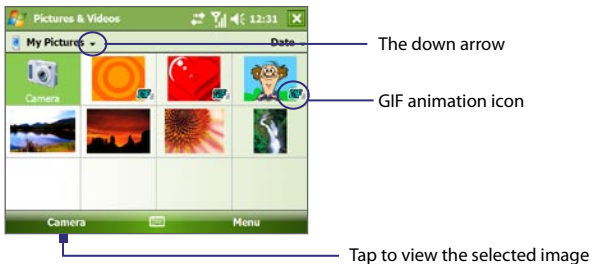

To play videos with audio

1. Tap **Start > Programs > Pictures & Videos**. By default, the contents of the My Pictures folder will be shown.

2. To find the video clips that you captured, tap the down arrow (▼) next to the My Pictures folder and tap My Documents. Next, tap My Videos. Video clips are displayed as thumbnails by default, which appear with a media icon (📺).



The media icon

3. Tap to select a video and play it in Windows Media Player Mobile.

To view slide shows

You can view your pictures as a slide show on your device. Pictures are shown in full-screen view with 5-second intervals between slides.

1. Tap **Start > Programs > Pictures & Videos**.
2. Tap **Menu > Play Slide Show**.

Note You can specify how pictures are scaled to optimize their display in a slide show. Tap **Menu > Options**, then tap **Portrait pictures** or **Landscape pictures** on the **Slide Show** tab.

Tap anywhere on the screen to display the Slide Show toolbar, which you can use to stop or pause the slide show, rotate the view, and more.

To sort pictures and video clips

If you store a large number of pictures or video clips on your device, you may find it helpful to sort them to quickly find a specific picture or clip. You can sort by name, date, and size.

1. Tap **Start > Programs > Pictures & Videos**.
2. Tap the sort list (labeled **Date** by default), and select the item you want to sort by (**Name**, **Date**, or **Size**).

To delete a picture or video clip

Do any of the following to remove a picture or a video clip:

- Select a picture or video clip on the Pictures & Videos screen, and tap **Menu > Delete**.
- Tap and hold the thumbnail of the picture you want to delete, then tap **Delete**.

Tap **Yes** to confirm the deletion.

To edit a picture

You can rotate, crop, and adjust the brightness and color contrast of your pictures.

1. Tap **Start > Programs > Pictures & Videos**.
2. Tap the picture you want to edit.
3. Tap **Menu > Edit**, and do any of the following:
 - To rotate a picture 90 degrees clockwise, tap **Rotate**.
 - To crop a picture, tap **Menu > Crop**. Next, tap and drag to select the area to crop. Tap inside the box to crop, or tap outside the box to cancel cropping.
 - To adjust the brightness and contrast levels of a picture, tap **Menu > Auto Correct**.

Note To undo an edit, tap **Menu > Undo**. To cancel all unsaved edits you made to the picture, tap **Revert to Saved**.

To set a picture as the Today screen background

You can use a picture as the background on the Today screen.

1. Tap **Start > Programs > Pictures & Videos**.
2. Select the picture you want to set as the background.
3. Tap **Menu > Set as Today Background**.
4. In **Transparency level**, select a higher percentage for a more transparent picture, or a lower percentage for a more opaque picture.
5. Tap **OK**.

To send pictures and video clips via e-mail

You can send pictures and video clips to other devices via e-mail.

1. First, set up Messaging to send and receive messages.
2. From the program, select the item you want to send.
3. Tap **Menu > Send**, and select one account (such as Outlook E-mail or MMS) to send the attached item.
4. A new message is created with the item attached.
5. Enter the recipient name and subject, and tap **Send**. The message will be sent the next time you synchronize your device.

Note Pictures and video clips are saved automatically before they are sent.

To assign pictures to contacts

You can assign a picture to a contact so that you can easily identify the contact at any point of time.

1. Tap **Start > Programs > Pictures & Videos**.
2. Select the picture you want to assign to a contact.
3. Tap **Menu > Save to Contact**.
4. Tap the contact, or navigate and tap **Select** to choose the contact from your Contacts list.

To customize more image settings

1. Tap **Start > Programs > Pictures & Videos**.
2. Select the picture for which you want to configure further settings.
3. Tap **Menu > Options**. The Options screen appears, allowing you to:
 - Resize a picture so that it can be sent faster through e-mail.
 - Set the direction of rotation for the Rotate function.
 - Configure the view settings during slide shows and activate screensaver options.

12.3 Using Windows Media Player Mobile

You can use Microsoft Windows Media Player Mobile 10 for Pocket PC to play digital audio and video files that are stored on your device or on a network, such as on a Web site.









Using Windows Media Player Mobile, you can play both audio and video files. These are the following file formats that are supported by this version of Windows Media Player Mobile.

Video File Formats Supported	File Extensions
<ul style="list-style-type: none">• Windows Media Video• MPEG4 Simple Profile• H.263• Motion JPEG• 3GPP2	<ul style="list-style-type: none">.wmv, .asf.mp4.3gp.avi.3g2
Audio File Formats Supported	File Extensions
<ul style="list-style-type: none">• Windows Media Audio• MP3• MIDI• AMR Narrow Band• AMR Wide Band• AAC• 3GPP2	<ul style="list-style-type: none">.wma.mp3.mid, .midi, .rmi.amr.awb.m4a.gcp

About the controls

The following are available controls on the Windows Media Player Mobile.



This control	Does this
1 	Plays/Pauses a file.
2 	Displays the video in full screen.
3 	Displays a Web site where you can find music and videos to play.
4 	Adjusts the playback progress of a selected file.
5 	Skips to the beginning of the current file or to the previous file.
6 	Skips to the next file.
7 	Decreases the volume level.
8 	Increases the volume level.
9 	Turns the sound on or off.

About the screens and menus

Windows Media Player Mobile has three primary screens:

- **Playback screen.** The default screen that displays the playback controls (such as Play, Pause, Next, Previous, and Volume) and the video window. You can change the appearance of this screen by choosing a different skin.
- **Now Playing screen.** The screen that displays the Now Playing playlist. This special playlist indicates the current file being played and any files that are “queued up” to play next.
- **Library screen.** The screen that lets you quickly find your audio files, video files, and playlists. It contains categories such as My Music, My Videos, My TV, and My Playlists.

At the bottom of each screen, you can open a **Menu**. The commands on this menu vary, depending upon which screen you are viewing. For more information about the commands in these menus, see Help on your device.

About licenses and protected files

Some content (such as digital media files downloaded from the Internet, CD tracks, and videos) have associated licenses that protect them from being unlawfully distributed or shared. Licenses are created and managed by using digital rights management (DRM), which is the technology for securing content and managing its access rights. Some licenses may prevent you from playing files that have been copied to your device. Files that have licenses associated with them are called “protected files.”

If you want to copy a protected file from your PC to your device, use the desktop Player to synchronize the file to your device (instead of dragging the file from a folder on your PC to a folder on your device, for example). This will ensure that the license is copied along with the protected file. For more information about synchronizing files to your device and other mobile devices, see desktop Player Help.

Note You can view the protection status for a file by checking its file properties (tapping **Menu** > **Properties**).

Copy media files to your device

Use the latest version of the desktop Player (Windows Media Player 10 or later) to synchronize digital media files to your device (instead of dragging a file from a folder on your PC to a folder on your device, for example). Using the desktop Player ensures that licenses are copied with protected files.

Always synchronize the files to a storage card that is inserted into your device. Do not synchronize to a storage card that is inserted into a storage card reader. In addition, do not synchronize to the internal storage location (RAM) in your device.

To synchronize content to your device automatically

1. Power off your device. Insert a 32-MB or larger storage card into your device, and turn the power back on.
2. On your PC, start Windows Media Player.
3. Connect your device to your PC.
4. If you have not set up synchronization between your device and PC, the Device Setup Wizard opens on your PC.
5. In the wizard, click **Automatic**, select the **Customize the playlists that will be synchronized** check box, and then select the playlists that you want to synchronize.
6. Click **Finish**.
7. The files begin synchronizing to your device. The next time you connect your device to your PC while the desktop version of Windows Media Player is running, synchronization will start automatically.

To synchronize and copy content manually to your device

1. If you have not set up synchronization between your device and PC, follow steps 1 to 6 in “To synchronize content to your device automatically,” except that you should click **Manual** synchronization.
2. To choose files to synchronize and copy to your device, do the following:
 - Click the **Library** tab.
 - In the rightmost pane, click the drop-down list and select **Sync List**.

- In the Playlist which is the leftmost pane, select a desired playlist.
- In the File List which is the middle pane, multi-select desired files then drag them to the Sync List.
- Click the **Start Sync** button found at the bottom of the Sync List.

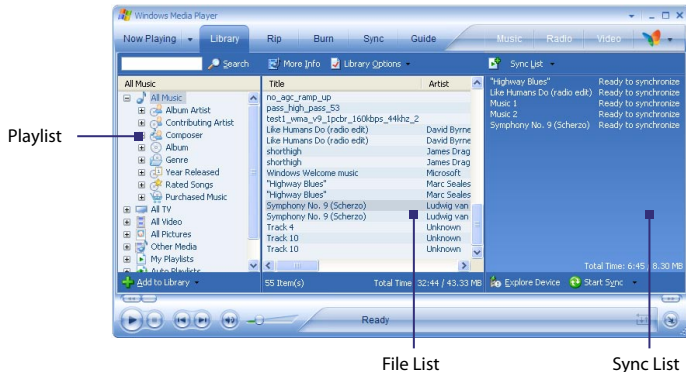

Note Audio files copy faster if the desktop Player is configured to automatically set the quality level for audio files copied to your device. For more information, see desktop Player Help on the PC.

Play media

To play items on your device

Use the library on Windows Media Player Mobile to find and play songs, videos, and playlists that are stored on your device or removable storage card.

1. If you are not on the Library screen, tap **Menu > Library**.
2. On the Library screen, tap the Library arrow (near the top of the screen), then tap the media storage that you want use, for example, Storage Card.

3. In most cases, Windows Media Player Mobile automatically updates the library. However, you can manually update the library to ensure that it contains new files that you recently copied to your device or storage card. Tap **Menu > Update Library** to manually update the library list.
4. Select a category (for example, My Music or My Playlists).
5. Tap and hold the item that you want to play (such as a song, album, or artist name), then tap **Play**.

Note To play a file that is stored on your device but is not in a library, on the Library screen, tap **Menu > Open File**. Tap and hold the item that you want to play (such as a file or a folder), then tap **Play**.

To play an item on a network

Use the **Open URL** command to play a song or video that is stored on the Internet or on a network server.

1. If you are not on the Library screen, tap **Menu > Library**.
2. Tap **Menu > Open URL**.
3. Do one of the following:
 - In the **URL** box, enter a network address.
 - In the **History** box, tap a URL that you have previously used.

Note To play an item on a network, you must be connected to a network. For more information about creating a remote connection between your device and a network, see [Connections Help](#) on your device.

Use playlists

A playlist is a list of digital media files that play in a specified order. By using playlists, you can group audio and video files together for convenient playback.

In the desktop Player, you can create a playlist of media files and synchronize the desktop Player with your device. For more information about synchronizing media, see “Copy media files to your device” earlier in this chapter.

In Windows Media Player Mobile on your device, your playlists are available in the Library under the My Playlists category. There is also a temporary playlist, called Now Playing, which lists the currently playing file, as well as any files that have been queued up to play next. You can create a new playlist on your device by saving the current Now Playing playlist and by giving it a new name.

To save a new playlist

1. If you are not on the Library screen, tap **Menu > Library**.
2. Tap to select a category (for example, My Music or My Playlists).
3. Select a media file that you want, then tap **Menu > Queue Up**. This adds the file to the Now Playing list.

Repeat this step until you have added all desired media files to the Now Playing list.

Note You cannot select multiple files simultaneously.

4. After adding the media files, tap **Menu > Now Playing**.
5. On the Now Playing screen, tap **Menu > Save Playlist**.
6. Enter the playlist name then tap **Done**.
7. To play back the playlist you created, tap My Playlists in the Library, select your playlist, then tap **Play**.

Troubleshooting









If you encounter a problem while using the Windows Media Player Mobile, a number of resources are available to help you troubleshoot the issue.

For more information, see the Troubleshooting Windows Media Player Mobile page at the Microsoft Web site (<http://www.microsoft.com/windows/windowsmedia/player/windowsmobile/troubleshooting.aspx>).

12.4 Using Streaming Media

The **Streaming Media** program allows you to stream live broadcasts or on-demand media content from the Web. You do not have to wait until the entire media content is completely downloaded before watching the video or hearing the sound. The media is sent in a continuous stream to your device and is played as it arrives, along with the audio.



Button control	Function
1 	Play/Pause
2 	Jog Bar (for scrubbing video)
3 	Zoom out
4 	Zoom in
5 	Stop
6 	Mute
7 	Decrease volume
8 	Increase volume
9 	Current volume level

The Streaming Media program allows you to play **3GP** and **MPEG-4** files. It also supports playback of **SDP** (Session Description Protocol) files. An SDP file is a text file that contains the format, broadcast times, media content, and other information about a live broadcast, or it may contain a playlist and links to prerecorded media files if you are viewing on-demand streaming media.

To access streaming content via Internet Explorer

In Internet Explorer, you can open a Web page containing RTSP links to streaming media content then play the content in the Streaming Media program.

1. Tap **Start > Internet Explorer**.
2. In the address bar, enter the URL address of the Web page that contains the RTSP link to the desired *.3gp, *.mp4, or *.sdp file.
3. On the Web page, tap the RTSP link.
4. Streaming Media then automatically opens and starts playing the file. During playback, use the button controls to play/pause, zoom in or out, adjust the sound volume, and more.

To stream media files directly on the Streaming Media

Streaming Media only supports RTSP links when you stream *.3gp and *.mp4 files directly on the program.

Note Before you launch the Streaming Media program, make sure that you are connected to the Internet.

1. Tap **Start > Programs > Streaming Media**.
2. From the program, tap **Connect**.
3. Enter the URL for the Web site (rtsp://) and the file name.
Alternatively, if you already accessed RTSP links before, you can simply tap an RTSP link in the **History** list to play previously viewed content.
4. Tap **Connect**.
5. Streaming Media then starts playing the file. During playback, use the button controls to play/pause, zoom in or out, adjust the sound volume, and more.

To view streaming video file information

You can view the properties and general information of a streaming video clip, such as file format, audio codec, dimension, frames, and duration of the video.

- Tap **Menu > Properties** from the program.

To configure streaming video connection settings

Tap **Menu > Options** to configure the following settings:

- **Connect via.** Choose whether you want to connect to the Internet or corporate network (intranet) to locate a streaming video clip.
- **UDP port range.** Specify a range of port numbers to use for streaming.
- **Media buffer.** Specify the memory space (in terms of duration) to allot for storing video and audio data while streaming media.

Chapter 13

Using Other Applications

13.1 Word Mobile

13.2 Excel Mobile

13.3 Viewing Slide Shows with PowerPoint Mobile

13.4 Using Adobe Reader LE

13.5 Using MIDlet Manager

13.6 Using ZIP

13.7 Using Voice Speed Dial

13.1 Word Mobile

Word Mobile is a streamlined version of Microsoft Word. Word documents created on your PC can be opened and edited on your device. You can also create and edit documents and templates in Word Mobile and save them as ***.doc**, ***.rtf**, ***.txt**, and ***.dot** files.

You can have only one document open at a time. When you open a second document, the first one is saved and closed automatically.

To create a Word file

1. In Word Mobile, tap **New**. You will see either a blank document or template, depending on what you have selected as the default template.
2. Enter text as desired.
3. Tap **Menu**, then choose whether to set the font, paragraph alignment and indentation, insert the date, do a spelling check, and more.
4. When finished, tap **OK** to save and close the file.

When you close a newly created document, it is automatically named after the first several words in the document and placed in the Word Mobile document list. You can easily rename the document with a more meaningful name and move it to another folder or a storage card.

Note Word Mobile does not fully support some features of Microsoft Word such as revision marks and password protection. Some data and formatting may be lost when you save the document on your device. To see a complete list of features that are not supported in Word Mobile, see Help on your device.

13.2 Excel Mobile

Excel Mobile makes it easy for you to open and edit Excel workbooks and templates created on your PC. You can also create new workbooks and templates on your device.

To create an Excel file

1. In Excel Mobile, tap **New**. You will see either a blank worksheet or template, depending on what you've selected as the default template.
2. Tap a cell to select it. Using the on-screen keyboard, enter your data then tap the **Enter** key.
3. Tap **Menu**, then choose whether to insert cells, charts, symbols or functions, format rows and columns, and more.
4. When finished, tap **OK** to save and close the file.

- Tips**
- Work in full-screen mode to see as much of your workbook as possible.
 - Tap **View > Zoom** and select a percentage so that you can easily read the worksheet.

Note Excel Mobile does not fully support some features such as formulas and cell comments. Some data and formatting may be lost when you save the workbook on your device. To see a complete list of features that are not supported in Word Excel, see Help on your device.

13.3 Viewing Slide Shows with PowerPoint Mobile

With **PowerPoint Mobile**, you can open and view slide show presentations created on your PC. Slide shows in ***.ppt** and ***.pps** format created using PowerPoint '97 and later can be viewed in PowerPoint Mobile.

Many presentation elements built into the slide shows such as slide transitions and animations will play back on the device. If the presentation is set up as a timed slide show, one slide will advance to the next automatically. Links to URLs are also supported.

Features not supported in PowerPoint Mobile include:

- **Notes.** Notes written for slides will not be visible.
- **Rearranging or editing slides.** PowerPoint Mobile is a viewer only.

- **Some file formats.** Files created in ***.ppt** format earlier than PowerPoint '97 and HTML files in ***.htm** and ***.mht** formats are not supported.

To start a slide show presentation

1. Tap **Start > Programs > PowerPoint Mobile**.
2. In the presentation list, tap the slide show you want to view.
3. Tap the current slide to advance to the next slide.
4. To navigate between slides, tap **▲ | > Next** or **Previous**, or tap **Go to Slide** and tap the slide you want to view.

If the presentation is set up as a timed slide show, slides will advance automatically.

- Notes**
- If you have zoomed in to see a slide in more detail, you cannot navigate to another slide until you zoom out.
 - Tapping **Next** or **Previous** may play an animation on a slide rather than navigate to another slide.

To stop a slide show

- In a PowerPoint Mobile presentation, tap **▲ | > End Show**.

13.4 Using Adobe Reader LE

Adobe Reader LE allows you to open and view Portable Document Format (PDF) files. These files usually have a ***.pdf** file extension.

To open a PDF file on your device

1. Tap **Start > Programs > Adobe Reader LE**.
2. Tap **Open**.
3. Browse to a folder and tap the PDF file you want to view.

Note To open another PDF file, tap **Menu > Open**. Tap **Browse**, select the desired file, and tap **Open**. You can also open a PDF file from File Explorer.

To navigate through a PDF file

You can do any of the following:

- Tap the Up, Down, Right, and Left arrow keys on the horizontal and vertical scrollbars to move to the desired direction of the page.
- Press NAVIGATION up, down, right, and left to move up or down a page or scroll through the pages.
- Tap the space between the arrow keys and the scrollbar with your stylus to move one screen towards the desired position.
- Tap and drag the scrollbar tab to quickly scroll through pages and jump to a desired page number.
- Tap **Tools > Go To** and select an option to go to a specific page in a multi-page PDF file.

To enlarge or reduce the display size

1. Open a PDF file you want to view.
2. Tap **Tools > Zoom**.
3. Select **In** or **Out** to enlarge or reduce the display size. Otherwise, select **Fit Screen** or **Fit Width**.
4. Select **To %** to set an arbitrary zoom ratio.

To change page view and orientation

1. Open a PDF file you want to view.
2. Tap **Tools > View**.
3. Select an option to suit your view.









To find text in a PDF file

1. Open a PDF file you want to view.
2. Tap **Tools > Find > Text**.
3. Enter the text to be searched.
4. Choose search parameters, such as Match case, Whole word, Backwards, and tap **Find**.

- Notes**
- Adobe Reader LE displays a bookmark pane for the PDF files that contain bookmarks. You can tap the bookmarks to go to a specific section/page within the file.
 - Adobe Reader LE supports password protected PDF files with up to 128-bit encryption. When you open a password-protected PDF file, you will be prompted to enter the password before the file can be opened.

To use the toolbar

You can also use the Adobe Reader LE toolbar to access the most commonly used functions. The following table lists the toolbar controls.

This Control	Does This
	Fits the entire page to the screen
	Fits the page width to the screen
	Displays the first page
	Displays the previous page
	Displays the next page
	Displays the last page
	Displays the text search screen
	Zooms out
	Zooms in

13.5 Using MIDlet Manager

MIDlets are Java applications that can run on mobile devices. Your device supports Java™ 2 Micro Edition, J2ME™. The **MIDlet Manager** allows you to download Java applications, such as games and tools that are specifically designed for mobile devices. Although some Java applications and games have already been installed on your device, the Java MIDlet Manager gives you the flexibility of installing and managing additional J2ME applications from the Internet.

To install MIDlets from the Internet

1. Locate the MIDlet/MIDlet suite while connected to the Internet.
2. Select the MIDlet/MIDlet suite to download.
3. Confirm to start downloading.
4. Run the file(s) to install.

To install MIDlets from a PC

You can install the MIDlets/MIDlet suites on your device from a PC using the USB sync cable or Bluetooth. MIDlets copied to your device are automatically saved in the My Documents folder. However, you can copy the MIDlet file(s) from a PC to any of the following temporary folders on your device from where MIDlet Manager can install them.

- Device memory: ../My Device/My Documents/My MIDlets
- Storage card/Microdrive: ../My Device/Storage Card or Microdrive

Note If the My MIDlets folder does not exist in My Documents, you can create one with the same folder name. However, a folder named Storage Card automatically appears after you insert a storage card into your device.

To install a MIDlet/MIDlet suite

1. Tap **Start > Programs > MIDlet Manager > Menu > Install > Local**.
2. From the list, tap the MIDlet/MIDlet suite that you want to install.
3. Confirm to complete the installation.

Note To remove a MIDlet file from the temporary folder, tap and hold the file then tap **Delete** from the shortcut menu.

To run MIDlets on your device

1. Tap **Start > Programs > MIDlet Manager**.
2. Tap a MIDlet to run.

To view the MIDlets currently running

- Tap the down arrow on the top left of the MIDlet Manager screen, then tap **Running**.

Note To view the most recently used MIDlets, tap **Show > Recent**.

To stop running a MIDlet

1. Tap the down arrow on the top left of the MIDlet Manager screen, then tap **Running**.
2. Tap and hold a MIDlet on the Running MIDlets screen, and tap **Stop**.

Note To stop all MIDlets currently running on your device, tap **Menu > Stop All**.

Manage MIDlets/MIDlet suites

You can organize the MIDlets into groups and define custom groups. You can also change the default settings for a MIDlet.

To associate a MIDlet/MIDlet suite to a group

If you installed several MIDlets/MIDlet suites to your device, you can categorize them into groups.

1. Tap and hold on a MIDlet/MIDlet suite, then tap **Group**.
2. Choose a preset group, or tap **New** if you want to create a custom group, then tap **OK**.

After you have assigned MIDlets/MIDlet suites to respective groups, the group names will appear in the Show menu and you can display them by group.

To select a sorting order

1. Tap the down arrow on the top right of the MIDlet Manager screen to open the **Sort By** menu.
2. Choose to sort by **Name** or by **Size**.

To change the display name of a MIDlet

1. Tap and hold a MIDlet, and tap **Rename**.
2. Enter a new name for the MIDlet, then tap **OK**.

Note You cannot change the name of a MIDlet suite.

To uninstall a MIDlet/MIDlet suite

Before you uninstall a MIDlet/MIDlet suite, make sure that it is not running.

1. Tap and hold the MIDlet/MIDlet suite, and tap **Uninstall**.
2. Tap **OK** to confirm.

Note You cannot uninstall a single MIDlet from a MIDlet suite; you can uninstall only the complete MIDlet suite.

To check storage space

- Tap **Menu > System Info** on the MIDlet Manager screen to see how much device storage space is used by MIDlets.

To select a type of connection

- Tap **Menu > Choose Network Type** on the MIDlet Manager screen, and select the type of connection that you will use for downloading MIDlets to your device.

To configure MIDlet security

You can adjust security settings for each MIDlet/MIDlet suite.

1. Tap and hold a MIDlet.
2. Tap **Security** from the shortcut menu.

Note that some features may not be available for all MIDlets/MIDlet suites. The following are the security options that you can set for a running MIDlet/MIDlet suite.

Security Option	Description
Net Access	Determines whether a MIDlet/MIDlet suite can access the Internet.
Local Connectivity	Enables a MIDlet/MIDlet suite to access services, such as Bluetooth.
App Auto Run	Enables a MIDlet/MIDlet suite to run at specified times, or any time.
Messaging	Determines whether a MIDlet/MIDlet suite can send and/or receive SMS messages.
Multimedia Recording	Enables a MIDlet/MIDlet suite to record sounds and images.

Note For a list of error messages that you may receive while managing and using MIDlets/MIDlet suites on your device, see [Help on your device](#).

13.6 Using ZIP

This feature allows you to save memory and increase the storage capacity of your device by compressing files in the conventional ZIP format. You can view and extract archive files received from various sources. You can also create new ***.zip** files on your device.

Start ZIP and Open .zip files

You can use **ZIP** to either archive files or open an existing archive file on your device. Each time you start ZIP on your device, it searches for files that have the .zip file extension, and displays these files on the Archive List screen.

To start ZIP on your device

- Tap **Start > Programs > ZIP**.

To open a ZIP file and extract files

1. Open a file using any of the following:
 - Select a file and tap **File > Open Archive**.
 - Tap and hold a file and tap **Open Archive**.
 - Double-tap a file.

Note You cannot select multiple ZIP files.

2. The files contained in the zip file are then displayed. Select files by doing one of the following:
 - Tap to select a file.
 - To select several files, tap **Menu > Action** and make sure **Multi-Select Mode** is selected. Select files by tapping each file. (Tap a selected file to deselect it).
 - To select all files, tap **Menu > Action > Select All**.
3. Tap **Menu > Action > Extract**.
4. Choose a folder in which files will be extracted to, then tap **Extract**.

To create a zip archive

1. Tap **New** or **File > New Archive**.
2. On the Save As screen, enter a zip file name and choose a folder in which to save the zip file. You can also choose whether the zip file will be saved on the device's main memory or a storage card.
3. Tap **Save**.
4. Tap **Menu > Action > Add**.
5. Double-tap the folder that contains the files you want to archive.
6. Select files by doing one of the following:
 - Tap to select a file.
 - To select several files, tap and hold on the screen, then select **Multi-Select Mode**. Select files by tapping each file. (Tap a selected file to deselect it).
 - To select all files, tap and hold on the screen, then tap **Select All**.
7. Tap **Add**.
8. Tap **Menu > File > Close Archive**.
9. After closing the zip file, you can tap **Menu > File > Find Archive** to search for all zip files and display them on the Archive List screen.





13.7 Using Voice Speed Dial

You can record voice tags so that you can dial a phone number or launch programs simply by speaking a word.

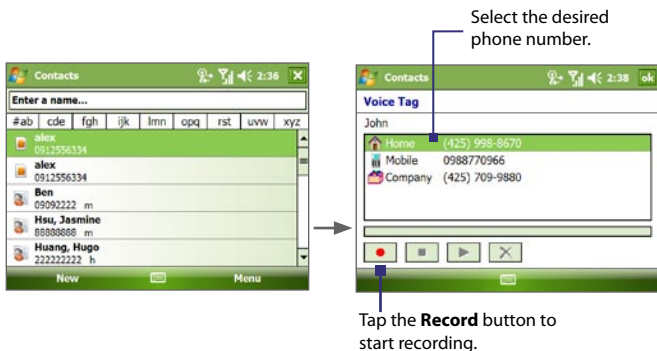
Create voice tag for a phone number

1. Tap **Start** > **Contacts** to open the Contacts list.
2. Do one of the following:
 - Tap and hold the desired contact, then tap **Add Voice Tag**.
 - Select the desired contact, then tap **Menu** > **Add Voice Tag**.
 - Tap the desired contact to open the contact's detailed screen, then tap **Menu** > **Add Voice Tag**.
3. Select the phone number that you want to create a voice tag, then tap the **Record** button ().



4. When completed, a **Voice Tag** icon () will be displayed on the right of the item.
5. When you create a voice tag for the item, you can do one of the following:
 - Tap the **Record** button () to rebuild the voice tag.
 - Tap the **Play** button () to play the voice tag.
 - Tap the **Delete** button () to delete the voice tag.

Tip To ensure voice recognition accuracy, please record your voice in a quiet place.

Create voice tag for a program



1. Tap **Start > Settings > Personal tab > Voice Speed Dial**.
2. The **Application** tab displays a list of all installed programs on your device. The procedure for creating a voice tag for a program is the same as the procedure for creating a voice tag for a phone number.
3. After you have created a voice tag for a program, you can then launch the program by saying the recorded voice tag after tapping **Start > Programs > Voice Speed Dial**.

Make a call or launch programs using voice tags

1. Tap **Start > Programs > Voice Speed Dial**.
2. After a “beep” sound, say the recorded voice tag that you have assigned to the phone number you want to call or the program you want to launch. The system will repeat the voice tag and then dial out or launch the program automatically.

Note If the system cannot recognize your voice, try again. Reduce the surrounding noises and speak more clearly

To view and test the voice tags you have created

1. Tap **Start > Settings > Personal tab > Voice Speed Dial**.
2. The **Voice Tag** tab displays a list that contains all the voice tags you have created. Select an item in the list, and you can do one of the following:
 - Tap the **Record** button () to rebuild the voice tag.
 - Tap the **Play** button () to play the voice tag.
 - Tap the **Delete** button () to delete the voice tag.

Chapter 14

Managing Your PDA Phone

14.1 Adding and Removing Programs

14.2 Copying Files

14.3 Managing Memory

14.4 Backing Up Data

14.5 Resetting Your PDA Phone

14.6 Checking System Information

14.7 Battery Saving Tips

14.1 Adding and Removing Programs

Before you purchase additional programs for your device, you should note the model name of your device, the version of Windows Mobile software running on it, and the type of processor. This information will help you select a program that is compatible with your device. For more information, see "To get detailed device information" and "To find the operating system version number" in this chapter.

Programs available for purchase usually include a Setup program (commonly named "setup.exe") that you must first run on your PC. You can then use ActiveSync to add programs to your device, or add a program directly from the Internet.

To add programs

1. Download the program to your PC (or insert the disc that contains the program into your PC). You may see a single *.exe file, a *.zip file, a Setup.exe file, or several versions of files for different device types and processors. Be sure to select a program designed for your device and processor type.
2. Read any installation instructions or documentation that comes with the program. Many programs provide special installation instructions.
3. Connect your device to the PC.
4. Double-click the *.exe file.
 - If the executable file is an installation wizard, follow the instructions on the screen. The wizard will automatically install the program to your device.
 - If an installation wizard does not start, you will see an error message stating that the program is valid but that it is designed for a different type of computer. You will need to copy this program directly to your device. If you cannot find any installation instructions for the program, use ActiveSync to copy the program file to the Program Files folder on your device.

To remove programs

You can only remove programs that you installed. Programs that come with your device cannot be removed.

1. Tap **Start > Settings > System** tab > **Remove Programs**.
2. In the **Programs in storage memory** list, select the program you want to remove, and tap **Remove**.
3. Tap **Yes**. If another confirmation message appears, tap **Yes** again.

14.2 Copying Files

You can copy files to your PC using ActiveSync, or copy files to a storage card you insert into your device. Your device has an expansion slot for inserting a miniSD™ card.

Using ActiveSync, you can copy or move information from the PC to your device and vice versa. Copying a file results in separate versions of a file on your device and PC. Because the files are not synchronized, changes made to one file will not affect the other.

Note If you want to automatically update information on both your device and PC, synchronize the information instead. For more information about copying and synchronizing files, see ActiveSync Help on your PC.

To copy files to a storage card or Microdrive

1. Make sure a miniSD™ card is properly inserted into your device.
2. Tap **Start > Programs > File Explorer** and navigate to the appropriate folder.
3. Tap and hold the file you want to copy, and tap **Copy**.
4. Tap the folder list (labeled **My Documents** by default) and tap **Storage Card** or **Microdrive**.
5. Tap **Menu > Edit > Paste**.

To copy a file between your device and the PC

1. Connect your device to the PC.
2. In ActiveSync, click **Explore**, which opens the Mobile Device folder of your device.
3. To copy a file from your device to your PC:
 - a. In the Mobile Device folder, go to the file that you want to copy.
 - b. Right-click the file, then click **Copy**.
 - c. Locate the destination folder on your PC. Right-click the folder, then click **Paste**.
4. To copy a file from your PC to your device:
 - a. On your PC, navigate to the folder that contains the file you want to copy.
 - b. Right-click the file, then click **Copy**.
 - c. Right-click the destination folder under Mobile Device, then click **Paste**.

To automatically save files on a storage card or Microdrive

In the Word Mobile or Notes programs, you may find it helpful to save all new documents, notes, and workbooks directly on a storage card.

1. From the program file list, tap **Menu > Options** or **Menu > Tools > Options**.
2. In the **Save to** box, select the storage card or the Microdrive to automatically save new files on the storage card or Microdrive.
3. Tap **OK**.

Note In the file or note list, a  symbol is displayed next to the names of files saved on a storage card/Microdrive.

14.3 Managing Memory

You may need to stop a program if it becomes unstable or the program memory is low.

To see how much memory is available

- Tap **Start > Settings > System tab > Memory**.
- On the **Main** tab, the amount of memory allocated to file and data storage versus program storage is displayed, as well as the amount of memory in use versus the available memory.

To see available storage card or Microdrive memory

You can see how much memory is available on the Microdrive or a miniSD card that is inserted in your device.

1. Tap **Start > Settings > System tab > Memory**.
2. Tap the **Storage Card** tab.
3. Tap the list box and then select the storage media whose information you want to see.



Try the following to free memory on your device:

- Close programs you are not currently using.
- Move e-mail attachments to a storage card.
- Move files to a storage card. Tap **Start > Programs > File Explorer**. Tap and hold the file, and tap **Cut**. Browse to the storage card folder and tap **Menu > Edit > Paste**.
- Delete unnecessary files. Tap **Start > Programs > File Explorer**. Tap and hold the file, and tap **Delete**.
- Delete large files. To find your largest files, tap **Start > Programs > Search**. In the **Type** list, tap **Larger than 64 KB**, and tap **Search**.
- In Internet Explorer Mobile, delete temporary Internet files and clear history information. For more information, see "Internet Explorer Mobile" in Chapter 9.
- Remove programs you no longer use.
- Reset your device.

To close a program

Tapping the  button in a program may just close the program screen. In this case, the program continues to run in the background. You can end running programs manually by following these steps:

1. Tap **Start > Settings > System tab > Memory > Running Programs** tab.
2. In the **Running Programs List**, tap the program you want to end, and tap **Stop**.

- Tips**
- In most programs, you can also use the keyboard shortcut **CTRL+Q** to close the program.
 - You can configure the  button to directly shut down running programs. For more information, see “To configure the  button using Task Manager” in Chapter 4.

14.4 Backing Up Data

Use **Sprite Backup** to back up data, which includes settings, files, contacts, and all other information, to a storage card or to a designated folder on your device.

This section describes the basics on how to install Sprite Backup and use it to back up and restore data on your device. For more information about this program, see Help on your device:

To install Sprite Backup

1. Make sure your device is connected to your computer via a USB cable.
2. Install Sprite Backup on your device from the PC using the Application Disc. Follow the on-screen instructions on your computer to complete the installation.
3. After the installation is completed, the Setup Wizard on your computer will set up Sprite Backup on your device. Follow the on-screen instructions to complete the setup.

To open Sprite Backup

- On your device, tap **Start > Programs > Sprite Backup**.

Sprite Backup can operate in two different modes: **Basic mode** and **Advanced mode**. The first time you run Sprite Backup, it will be in **Basic Mode**. To switch between the modes, tap **Options** then select the desired mode.



Basic mode



Advanced mode

Basic mode

Basic mode is the default mode, and allows you to easily back up your entire Pocket PC with the tap of a button.

Note To change backup options or location, you will need to do it in **Advanced mode**.

To back up data in Basic mode

- On the Basic mode screen, tap **Backup Now**.
- Specify a password (between 6 to 15 characters in length) for the backup file. Enter this password twice, then tap **OK**.
- Follow the on-screen instructions to complete the backup.

To restore data in Basic mode

- On the Basic mode screen, tap **Restore Now**.
- Enter the password for the backup file, then tap **OK**.
- Follow the on-screen instructions to complete the restoration process.

Advanced mode

Advanced mode is designed for users with more advanced backup requirements. It provides a tree view of the data on your device from which you can select what items you want to back up or restore.

To back up data in Advanced mode

1. Tap **Options > Switch to Advanced Mode**.
2. The **Backup** tab of the Advanced mode screen shows a tree view of the data and files on your device. Tap the '+' symbol at the left of an item to view its sub-items. Use the check boxes to select or exclude items for backup.
3. Tap **Backup** and follow the on-screen instructions to complete the backup.

To restore data in Advanced mode

1. On the Advanced mode screen, tap the **Restore** tab.
2. If there is a most recent backup file, this file will be displayed with its contents. Otherwise, if you want to use an older backup file, tap  then select the desired file.

If the backup file is password protected, the password must be entered before the backup file can be displayed in the tree view.
3. In the tree view, select the check boxes of items you want to be restored.
4. Tap the **Restore** button and follow the on-screen instructions to restore.

Note In both the Basic and Advanced modes, Sprite Backup soft resets your device first before it begins the backup or restoration process. It soft resets again after the operation is completed.

Backup options

To change the backup location and file name

1. On the Advanced mode screen, tap the **Backup** tab.
2. Tap  then enter the backup file name and choose whether to save the file to the **Storage Card**, **Microdrive** or the **My Documents** folder on your device.
3. Tap **OK**.

To disable automatic file naming

1. Tap **Options > Backup Options > General Backup Options**.
2. Clear the **Name Backup Files Automatically** check box, then tap **OK**.
3. Before you perform a backup, tap then specify a backup file name.

To schedule automatic backups

1. Tap **Options > Scheduled Backup**, then tap **Change Scheduling**.
2. Select the **Enable Scheduled Backup** check box, and set the frequency of backups to perform, date and time, and other options.
3. Tap **OK**.

To enable remote backups to the computer via ActiveSync

1. Tap **Options > Networking**.
2. Select the **Enable Remote Backup** check box.
3. Select **Via ActiveSync**, then tap **OK**.
4. Tap then in the **Location list**, select **PC** and tap **OK**.

14.5 Resetting Your PDA Phone

Occasionally, you may need to reset your device. A normal (or soft) reset of your device clears all active program memory and shuts down all active programs. This can be useful when your device is running slower than normal, or a program is not performing properly. A soft reset is also necessary after the installation of some programs. If a soft reset is performed when programs are running, unsaved work will be lost.

You can also perform a hard reset (also known as a full reset). A hard reset should be performed only if a normal reset does not solve a system problem. After a hard reset, the device is restored to its default settings — the way it was when you first purchased it and turned it on. Any programs you installed, data you entered, and settings you customized on your device will be lost. Only Windows Mobile software and other pre-installed programs will remain.

To perform a soft reset

- Use the stylus to press the RESET button found on the back of the device. Your device restarts and displays the Today screen.

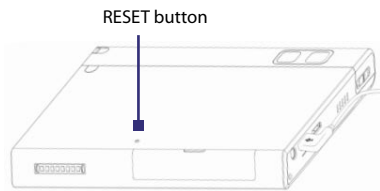

To perform a hard reset

Warning! Your device will be set back to factory default settings. Please ensure any additional installed programs and/or user data have been backed up before a hard reset is performed.

1. Slide the Volume slider down and at the same time, use the stylus to press the RESET button at the back of your device.

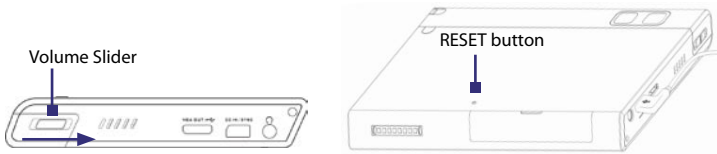

2. After a brief period of time, two choices will appear on-screen. Press the CENTER OK button to perform the hard reset.

Note If you do not want to perform a hard reset, press the CAMERA button to exit.

3. Press the POWER button.

14.6 Checking System Information

If you want to find out about technical details about your device such as the type or speed of the processor, memory size, etc., you can check under Settings for device information.

To find the operating system version number

- Tap **Start > Settings > System tab > About**.

The version of the operating system on your device is shown near the top of the About screen.

To get detailed device information

- Tap **Start > Settings > System tab > About**. The **Version** tab displays important device information, including the type of processor and the amount of memory that is installed.

14.7 Battery Saving Tips

How long your battery power lasts depends on battery type and how you use your device. Try the following to help preserve battery life:

To find the operating system version number

- When the device is not in use, press POWER to switch off the display.
- Tap the battery icon () on the Today screen. On the **Advanced** tab of the Power settings screen, you can specify when your device automatically turns off the display to conserve battery power. For optimum conservation, specify 3 minutes or less.
- Use the AC adapter to plug your device into external power whenever possible, especially when using a microSD card or when using a modem or other peripherals.
- Adjust the backlight settings. For more information, see “To set the backlight to dim after a time delay” in Chapter 4.
- Turn Bluetooth off when you are not using it.

- Make the device visible to other devices only when you are trying to establish a Bluetooth partnership. For more information, see “Using Bluetooth” in Chapter 9.
- Enable your device to receive incoming beams setting only while you are trying to receive beamed files. To find this setting, tap **Start > Settings > Connections > Beam**.
- Lower the volume.
- Close battery-intensive programs, such as the Camera, when you are done using them. Make sure the programs are ended and are not continuously running in the background. For more information about ending running programs, see “To close a program” in this chapter.

Appendix

A.1 Regulatory Notices

A.2 PC Requirement to Run ActiveSync 4.x

A.3 Specifications

A.1 Regulatory Notices

Regulatory Agency Identifications

For regulatory identification purposes, your product is assigned a model number of **ATHE100**. FCC ID: NM8ATHE100.

To ensure continued reliable and safe operation of your device, use only the accessories listed below with your **ATHE100**.

The Battery Pack has been assigned a model number of **ATHE160**.

This product is intended for use with a certified Class 2 Limited Power Source, rated 5 Volts DC, maximum 1 Amp power supply unit.

European Union Notice

Products with CE marking comply with the R&TTE Directive (99/5/EC), the EMC Directive (89/336/EEC), and the Low Voltage Directive (73/23/EEC) issued by the Commission of the European Community.

Compliance with these directives implies conformity to the following European Norms (in parentheses are the equivalent international standards).

- **EN 60950-1 (IEC 60950-1)**
Safety of InformationTechnology Equipment.
- **ETSI EN 301 511**
Global system for mobile communications (GSM); Harmonized EN for mobile stations in the GSM 900 and GSM 1800 bands, covering essential requirements of article 3.2 of the R&TTE directive (1995/5/EC).
- **ETSI EN 301 489-1**
Electromagnetic compatibility and Radio spectrum Matters (ERM); ElectroMagnetic Compatibility (EMC) standard for radio equipment and services; Part 1: Common technical requirements.
- **ETSI EN 301 489-7**
Electromagnetic compatibility and Radio spectrum Matters (ERM); ElectroMagnetic Compatibility (EMC) standard for radio equipment and services; Part 7: Specific conditions for mobile and portable radio and ancillary equipment of digital cellular radio telecommunications systems (GSM and DCS).
- **ETSI EN 301 489-17**
Electromagnetic compatibility and Radio spectrum Matters (ERM); ElectroMagnetic Compatibility (EMC) standard for radio equipment

and services; Part 17: Specific conditions for 2.4 GHz wideband transmission systems and 5 GHz high performance RLAN equipment.

- **EN 301 489-24**
Electromagnetic compatibility and radio spectrum matters (ERM); ElectroMagnetic Compatibility (EMC) standard for radio equipment and services; Part 24: Specific conditions for IMT-2000 CDMA direct spread (UTRA) for mobile and portable (UE) radio and ancillary equipment.
- **EN 301 908**
Electromagnetic compatibility and Radio spectrum Matters (ERM); Base Stations (BS) and User Equipment (UE) for IMT-2000 third generation cellular networks.
- **ETSI EN 300 328**
Electromagnetic compatibility and Radio spectrum Matters (ERM); Wideband Transmission systems; data transmission equipment operating in the 2.4 GHz ISM band and using spread spectrum modulation techniques.
- **EN 50360:2001**
Product standard to demonstrate the compliance of mobile phones with the basic restrictions related to human exposure to electromagnetic fields (300 MHz - 3 GHz).
- **EN 50392:2002**
Generic standard to demonstrate the compliance of low power electronic and electrical apparatus with the basic restrictions related to human exposure to electromagnetic fields (10 MHz - 300 GHz) - General public.
- **EN 300 440-1&-2**
Electromagnetic compatibility and Radio spectrum Matters (ERM); Short range devices; Radio equipment to be used in the 1 GHz to 40 GHz frequency range; Part 1: Technical characteristics and test methods. Part 2: Harmonized EN under article 3.2 of the R&TTE Directive.
- **EN60601-1-2**
Medical electrical equipment - Part 1-2: General requirements for basic safety and essential performance - Collateral standard: Electromagnetic compatibility - Requirements and tests

CE 0560 !

This equipment may be operated in:							
AT	BE	BG	CH	CY	CZ	DE	DK
EE	ES	FI	FR	GB	GR	HU	IE
IT	IS	LI	LT	LU	LV	MT	NL
NO	PL	PT	RO	SE	SI	SK	TR

Federal Communications Commission Notice

This device complies with part 15 of the FCC Rules. Operation is subject to the following two conditions: (1) This device may not cause harmful interference, and (2) this device must accept any interference received, including interference that may cause undesired operation.

This equipment has been tested and found to comply with the limits for a Class B digital device, pursuant to Part 15 of the FCC Rules. These limits are designed to provide reasonable protection against harmful interference in a residential installation. This equipment generates, uses, and can radiate radio frequency energy and, if not installed and used in accordance with the instructions, may cause harmful interference to radio communications. However, there is no guarantee that interference will not occur in a particular installation. If this equipment does cause harmful interference to radio or TV reception, which can be determined by turning the equipment on and off, the user is encouraged to try to correct the interference by one or more of the following measures:

- Reorient or relocate the receiving antenna.
- Increase the separation between the equipment and receiver.
- Connect the equipment into an outlet on a circuit different from that to which the receiver is connected.
- Consult the dealer or an experienced radio or television technician for help.

Modifications

The FCC requires the user to be notified that any changes or modifications made to the device that are not expressly approved by High Tech Computer Corporation may void the user's authority to operate the equipment.

Safety Precautions for RF Exposure

Tests for SAR are conducted using standard operating positions specified by the FCC with the phone transmitting at its highest certified power level in all tested frequency bands. Although the SAR is determined at the highest certified power level, the actual SAR level of the phone while operation can be well below the maximum value. This is because the phone is designed to operate at multiple power levels so as to use only the power required to reach the network. In general, the closer you are to a wireless base station antenna, the lower the power output. Before a phone model is available for sale to the public, it must be tested and certified to the FCC that it does not exceed the limit established by the government-adopted requirement for safe exposure. The tests are performed in positions and locations (for example, at the ear and worn on the body) as required by the FCC for each model. (Body-worn measurements may differ among phone models, depending upon available accessories and FCC requirements). For body-worn operation, to maintain compliance with FCC RF exposure guidelines, use only High Tech computer, Corp. approved accessories. When carrying the phone while it is on, use the specific High Tech Computer Corp. supplied or approved carrying case, holster, or other body-worn accessory.

Use of non High Tech Computer Corp. approved accessories may violate FCC RF exposure guidelines and should be avoided.

SAR Information

- 0.482 W/Kg@1g (FCC)

Telecommunications & Internet Association (TIA) safety information

Pacemakers

The Health Industry Manufacturers Association recommends that a minimum separation of six inches be maintained between a handheld wireless phone and a pacemaker to avoid potential interference with the pacemaker. These recommendations are consistent with the independent research by and recommendations of Wireless Technology Research.

Persons with pacemakers:

- Should ALWAYS keep the phone more than six inches from their pacemaker when the phone is turned ON.
- Should not carry the phone in a breast pocket.
- Should use the ear opposite the pacemaker to minimize the potential for interference. If you have any reason to suspect that interference is taking place, turn your phone OFF immediately.

Hearing Aids

Some digital wireless phones may interfere with some hearing aids. In the event of such interference, you may want to consult your service provider, or call the customer service line to discuss alternatives.

Other Medical Devices

If you use any other personal medical device, consult the manufacturer of your device to determine if they are adequately shielded from external RF energy. Your physician may be able to assist you in obtaining this information.

Turn your phone OFF in health care facilities when any regulations posted in these areas instruct you to do so. Hospitals or health care facilities may be using equipment that could be sensitive to external RF energy.

Pacemakers

- Avoid using your phone near metal structures (for example, the steel frame of a building).
- Avoid using your phone near strong electromagnetic sources, such as microwave ovens, sound speakers, TV and radio.
- Avoid using your phone after a dramatic change in temperature.

WEEE Notice

The Directive on Waste Electrical and Electronic Equipment (WEEE), which entered into force as European law on 13th February 2003, resulted in a major change in the treatment of electrical equipment at end-of-life.

The purpose of this Directive is, as a first priority, the prevention of WEEE, and in addition, to promote the reuse, recycling and other forms of recovery of such wastes so as to reduce disposal.



The WEEE logo (shown at the left) on the product or on its box indicates that this product must not be disposed of or dumped with your other household waste. You are liable to dispose of all your electronic or electrical waste equipment by relocating over to the specified collection point for recycling of such hazardous waste. Isolated collection and proper recovery of your electronic and electrical waste equipment at the time of disposal will allow us to help conserving natural resources. Moreover, proper recycling of the electronic and electrical waste equipment will ensure safety of human health and environment. For more information about electronic and electrical waste equipment disposal, recovery, and collection points, please contact your local city center, household waste disposal service, shop from where you purchased the equipment, or manufacturer of the equipment.

RoHS Compliance

This product is in compliance with Directive 2002/95/EC of the European Parliament and of the Council of 27 January 2003, on the restriction of the use of certain hazardous substances in electrical and electronic equipment (RoHS) and its amendments.

A.2 PC Requirement to Run ActiveSync 4.5

To connect your device to the PC, you must have Microsoft® ActiveSync® program installed on your PC. ActiveSync 4.5 is included in the **Getting Started Disc**, which is compatible with the following operating systems and applications:

- Microsoft® Windows® 2000 Service Pack 4
- Microsoft® Windows Server® 2003 Service Pack 1
- Microsoft® Windows Server® 2003 IA64 Edition Service Pack 1
- Microsoft® Windows Server® 2003 x64 Edition Service Pack 1
- Microsoft® Windows® XP Professional Service Packs 1 and 2
- Microsoft® Windows® XP Home Service Packs 1 and 2
- Microsoft® Windows® XP Tablet PC Edition 2005
- Microsoft® Windows® XP Media Center Edition 2005
- Microsoft® Windows® XP Professional x64 Edition
- Microsoft® Outlook® 98, Microsoft® Outlook® 2000 and Microsoft® Outlook® XP, and Microsoft® Outlook® 2003 messaging and collaboration clients
- Microsoft® Office 97, excluding Outlook
- Microsoft® Office 2000
- Microsoft® Office XP
- Microsoft® Office 2003
- Microsoft® Internet Explorer® 4.01 or later (required)
- Microsoft® Systems Management Server 2.0

A.3 Specifications

System Information	
Processor	Baseband: QUALCOMM® MSM 6275 CPU: Intel® PXA270 624 MHz with ATI Graphic Chip W2284
Memory	- ROM: 128 MB - RAM: 64 MB SDRAM (Figures are the total ROM and RAM memory available for use and storage. Since the memory is shared by the Operating System, applications, and data, the actual available memory is less than what is written). - Microdrive: 8 GB
Operating System	Windows Mobile® 6 Professional
Power	
Battery	Rechargeable Lithium-ion polymer battery, 2100 mAh
Charging Time	Up to 4 hours
Battery Life (estimates)	Standby time: Up to 300 hours for GSM Up to 300 hours for UMTS Talk time (Screen off): Up to 5.5 hours for GSM Up to 4.5 hours for UMTS Video call: Up to 2 hours
AC Adapter	Voltage range/Frequency: 100 - 240V AC, 50/60 Hz DC output: 5V and 1A
Display	
LCD Type	5" transmissive TFT-LCD with backlight LEDs, touch-sensitive screen
Resolution	480 x 640 VGA resolution with 65K colors
Alignment	Landscape and Portrait
GPS	
Chipset	SirF StarIII with Ephemeris Extension support
Internal Antenna	Yes
GPS Receiver	20 parallel channels

Cellular Radio Module

Functionality HSDPA/UMTS (2100 for Europe, 850/1900 for USA)
GSM/GPRS/EDGE (850, 900, 1800, and 1900)

Mode Dual (GSM)

Internal Antenna Yes

Physical

Dimensions 133.1 mm (L) x 97.7 mm (W) x 16 mm (T)
Thickness with keyboard: 20 mm

Weight Less than 350g (with battery)

Camera Module

Type 3 megapixels with auto focus and flash light

Resolution Photo: 2048 x 1536 (QXGA), 1600 x 1200 (UXGA),
1280 x 1024 (SXGA), 640 x 480 (VGA), 320 x 240 (QVGA),
160 x 120 (QQVGA)
Video: 352 x 288 (CIF), 320 x 240 (QVGA), 176 x 144 (QCIF),
128 x 96

Digital Zoom Up to 8x

Connections

I/O Port

- HTC ExtUSB™ : an 11-pin mini-USB 2.0 and audio jack in one (ExtUSB is a proprietary connection interface that is trademarked by HTC).
- HTC proprietary 16-pin combined port (USB 1.1 host/ VGA and TV Out)

Car Antenna Connector Yes

GPS Antenna Connector Yes

Audio Stereo earphone/Microphone jack

Wireless Connections Bluetooth®, Wi-Fi®

Controls and Lights

Navigation Buttons	<ul style="list-style-type: none"> • 5-way navigation control/Enter button • Comm Manager/Voice Recorder • Camera button • OK button • Start button • Internet Explorer/VueFLO control button • Detachable QWERTY Keyboard • Volume Slider • Power button • Reset button
---------------------------	--------------------------------------------------------------------------------------------------------------------------------------------------------------------------------------------------------------------------------------------------------------------------------------------------------------------------------------------------------------------------

LEDs	<p>Notification LED 1 shows battery charging status.</p> <p>Notification LED 2 shows the GSM/UMTS standby/network status (Green) and GPS indicator (amber).</p> <p>Notification LED 3 shows the following:</p> <ul style="list-style-type: none"> • A blinking Blue light for Bluetooth system notification of powered-up and ready to transmit radio frequency signal. • A blinking Green light for Wi-Fi status. • When both Bluetooth and Wi-Fi are enabled, their lights blink alternately. <p>Notification LED 4 shows messages and notifications. Please see "Getting to Know Your Device and Accessories" in Chapter 1 to know the locations of the LEDs.</p>
-------------	-----------------------------------------------------------------------------------------------------------------------------------------------------------------------------------------------------------------------------------------------------------------------------------------------------------------------------------------------------------------------------------------------------------------------------------------------------------------------------------------------------------------------------------------------------------------------------------------------------------------------------------------------------------------------------------------------------------------------------------

Audio

Audio Controller	AGC
Microphone/ Speaker	Built-in/Dual, Hands-free
Headphone	AMR/AAC/WAV/WMA/MP3 codec

Expansion Slots

Card Slot	miniSD™ (Hot swap and SD 2.0 compatible)
------------------	------------------------------------------

Index

A

- A2DP 148
- About licenses and protected media 197
- ActiveSync 74
 - Comm Manager 134
 - copy files 221
 - install and set up 116
 - overview 32
 - synchronize 120
- Add and remove programs 220
- Adobe Reader 32, 208
- Alarms and notifications 71
- Answer/end a call 54
- Assign pictures to contacts 194
- Assign programs or shortcuts to hardware buttons 70

B

- Backlight 68, 69
- Back up data 224
- Battery
 - battery information 23
 - charge battery 24
 - check battery power 24
 - save battery power 136
- Beam
 - via Bluetooth 149
- Block Recognizer 44
- Bluetooth
 - Bluetooth Explorer 32, 151
 - Bluetooth file sharing 151
 - Bluetooth modem 154
 - Bluetooth shared folder 151
 - hands-free headset 148

- modes 146
- overview 145
- partnership (pairing) 146
- SIM Access Profile (SAP) 59
- stereo headset 148
- turn on and off 134
- visible 146
- Bluetooth Explorer 32
- Burst capture mode 177
- Button controls and LEDs 241
- Button settings 69

C

- Calculator 33
- Calendar 87
 - create appointments 87
 - send appointments 89
 - view appointments 88
- Calibration 26
- Camera
 - capture modes 176, 177
 - controls 177
 - file formats 177
 - icons 177
 - overview 33
 - settings 185
 - specifications 240
- Car kit phones 59
- Change
 - screen text size 69
- Clock & Alarms 35
- Close program 224
- Comm Manager 37, 134
- Conference call 58
- Connecting to the Internet 135
 - Dial-up 139

- GPRS/EDGE 138
- Start a data connection 140
- Wi-Fi 135
- Work network connections 139
- Contacts
 - add a contact on your device 82
 - Organize and search 83
 - Share contact information 84
- Contacts Picture capture mode 177
- Cookies 143
- Copy
 - files between device and PC 221
 - files to Microdrive 221
 - files to storage card 221
 - media files from PC to device 198
 - pictures and video clips from PC to device 190
- Customize
 - Start menu 65
- Customize the Today screen 63

D

- Delete pictures and videos 193
- Device name 68
- Digitally sign messages 129, 130
- Digital Rights Management (DRM) 197
- Digital signature
 - verify 129
- Dimensions and weight 240
- Direct Push 121, 134
- Disconnect data services 134
- Display settings 68
- Draw 93

E

- E-mail 109
 - add an attachment to an e-mail message 109
 - compose and send an e-mail message 109
 - customize e-mail settings 112
 - download e-mail messages 112
 - E-mail Setup Wizard 106
 - security 128
 - types of e-mail accounts 106
- Edit picture 193
- Emergency call 58
- Encrypt messages 129, 130
- Excel Mobile 207
- Exchange Server
 - schedule synchronization 121

F

- Favorites (Internet Explorer) 141
- File Explorer 33
- Find
 - device information 229
 - operating system version number 229
- Find contact
 - online 127
- Format Microdrive 36, 72

G

- Games 33
- GIF animation 191
- GPS 33, 158, 159

H

- Hardware keyboard 40
- Hard reset 228
- Help 32
- Home page (Internet Explorer) 141

I

- Input methods
 - Block Recognizer 44
 - Keyboard 43
 - Letter Recognizer 43
 - Symbol Pad 46
 - Transcriber 44
- International call 58
- Internet Explorer Mobile 32, 141
- Internet security settings 143
- Internet Sharing 155

K

- Keyboard
 - on-screen 43
 - QWERTY 40
- Keypad tone 66

L

- Letter Recognizer 43
- Library screen (Windows Media Player Mobile) 197
- Live Messenger 168

M

- Make call
 - from Call History 52

- from Contacts 52
- from Phone program 51
- from SIM Manager 53
- from Speed Dial 53

Memory 223, 239

- Messaging
 - MMS 100
 - overview 32

MIDlet Manager

- configure MIDlet security 213
- install MIDlets from Internet 211
- install MIDlets from PC 211
- manage MIDlets/MIDlet suites 212
- overview 33, 211
- uninstall MIDlets/MIDlet suites 213

MMS 100

- add audio clip 105
- add emoticon 104
- add text 104
- add Web page address from Favorites 104
- create and send 103
- MMS settings 101
- reply message 105
- view message 105

MMS Video capture mode 177, 181

Mute 58

N

- Notes 33, 47, 92
- Now Playing screen (Windows Media Player Mobile) 197

O

- Opera Browser
 - Open 144

- Overview 33, 144
- Use 144

Owner information 62

P

Panorama capture mode 177

Phone 32, 50, 51

Phone services 66

Pictures & Videos

- assign pictures to contacts 194
- delete 193
- edit picture 193
- file formats 190
- overview 33
- play GIF animation 191
- play videos 191
- sort 192
- view pictures 191
- view slideshows 192

Picture Theme capture mode 177

PIN 50

Playback screen (Windows Media
Player Mobile) 197

Playlists 200

Play GIF animation 191

Play media 199

Play videos 191

PowerPoint Mobile 207

Programs

- ActiveSync 32
- Adobe Reader 32
- Bluetooth Explorer 32
- Calculator 33
- Calendar 32, 87
- Camera 33, 176
- Comm Manager 37, 134

- Contacts 32, 82

- Excel Mobile 207

- File Explorer 33

- Format Microdrive 36

- Games 33

- Help 32

- Internet Explorer Mobile 32, 141

- Internet Sharing 155

- Messaging 32

- Messenge 33

- MIDlet Manager 33, 211

- Notes 33, 92

- Opera Browser 33

- Phone 32, 51

- Pictures & Videos 33, 190

- PowerPoint Mobile 207

- QuickGPS 33, 159

- SAPSettings 33, 59

- Search 33

- SIM Manager 33, 53

- Sprite Backup 33, 224

- STK (SIM Tool Kit) Service 33

- Streaming Media 34

- Tasks 34, 90

- Voice Recorder 34

- Voice Speed Dial 34, 216

- Windows Media Player Mobile 34,
195

- Word Mobile 206

- ZIP 34, 214

Put call on hold 57

Q

QuickGPS 33, 159

QWERTY keyboard 40

R

- Receive call 54
- Record voice note 93
- Regulatory notices 232
- Reply MMS 106
- Reset
 - hard reset 227
 - soft reset 227
- Review screen (Camera) 182
- Ring tone settings 65

S

- SAPSettings 33, 59
- Save picture from Web page 143
- Search 33
- Searching Information 47
- Secure/Multipurpose Internet Mail Extension (S/MIME) 128
- Security settings (Internet Explorer) 143
- Send pictures and videos via e-mail 194
- Settings (Connections tab)
 - Beam 37
 - Bluetooth 37
 - Connections 37
 - CSD Line Type 37
 - GPRS Setting 37
 - SMS Service 37
 - USB to PC 37
 - Wi-Fi 37
 - Wireless LAN 37
- Settings (Personal tab)
 - Buttons 34
 - Input 34
 - Lock 34
 - Menus 34
 - Owner Information 34
 - Phone 34
 - Sounds & Notifications 35
 - Today 35
 - Voice Speed Dial 35
- Settings (System tab)
 - About 35
 - Backlight 35
 - Certificates 35
 - Clear Storage 35
 - Clock & Alarms 35
 - Customer Feedback 35
 - Device Information 35
 - Encryption 35
 - Error Reporting 35
 - GPS 35
 - Key Lock 36
 - Memory 36
 - Microphone AGC 36
 - Power 36
 - Regional Settings 36
 - Remove Programs 36
 - Screen 36
 - Task Manager 36
 - Windows Update 36
- Set picture as Today screen background 193
- Set the time and date 62
- SIM Access Profile (SAP) 59
- SIM card 23
- SIM Manager 85
 - add a contact on your SIM card 85
 - copy contacts to the SIM card 86
 - copy SIM contacts to your device 86

- make call 53
- overview 33
- Smart Dialing 54
- Soft reset 228
- Sounds & Notifications 71
- Specifications 239
- Speed Dial 53
- Sports capture mode 177
- Sprite Backup 33, 224
- Start menu 65
- Still image capture modes 180
- STK (SIM Tool Kit) Service 33
- Storage card
 - check available space 223
 - copy files 221
- Streaming Media 202
- Streaming Media Player 34
- Subdisplay 31
- Swap/switch calls 57
- Symbol Pad 46
- Synchronize
 - schedule synchronization with Exchange Server 121
 - Windows Media Player Mobile 198
- System information 239

T

- Tasks 34, 90
- Task Manager 36, 69
- Temporary Internet files (Internet Explorer)
 - delete 143
- Text Messages 99
 - receive text messages 99
 - send text messages 99
- Text size
 - screen 69
 - Web pages 142
- Today Screen 27
- Transcriber 44
- Troubleshoot Windows Media Player Mobile 201
- Turn device on and off 25
- Turn phone function on and off 50, 134
- TV Out 36, 71
- TV Out setting 71

U

- USB modem 155
- USIM card 23

V

- Verify digital signature 129
- Video capture mode 181
- View
 - MMS 105
 - photo slideshows 192
 - pictures 191
- Voice call 51
- Voice note 93
- Voice Recorder 34, 94
- Voice Speed Dial
 - create voice tags 216
 - overview 34, 216
- Voice tags
 - create for phone numbers 216
 - create for programs 217
 - use 217
- Volume 51
- VueFLO 36, 140

W

Web pages

- layout 142
- text size 142

Wi-Fi 134

Windows Live Mobile 164

Windows Media Player Mobile

- file formats 195
- menus 197
- overview 34
- playlists 200
- troubleshoot 201

Word completion options 70

Word Mobile 206

Z

ZIP

- create archive 215
- open zip file and extract files 214
- overview 34, 214

Zoom (Camera) 183